

# **WCN3-0052SD-A21**

## **SPECIFICATION**

<b>WCN</b>			<b>CUSTOMER Confirmed</b>
<b>Prepared by</b>	<b>Checked by</b>	<b>Approved by</b>	
<b>Fei</b> 2016-7-7	<b>Athena</b>	<b>William</b>	
<b>REVISION RECORD</b>			

**REVISION: A0**

## Outer Dimension:

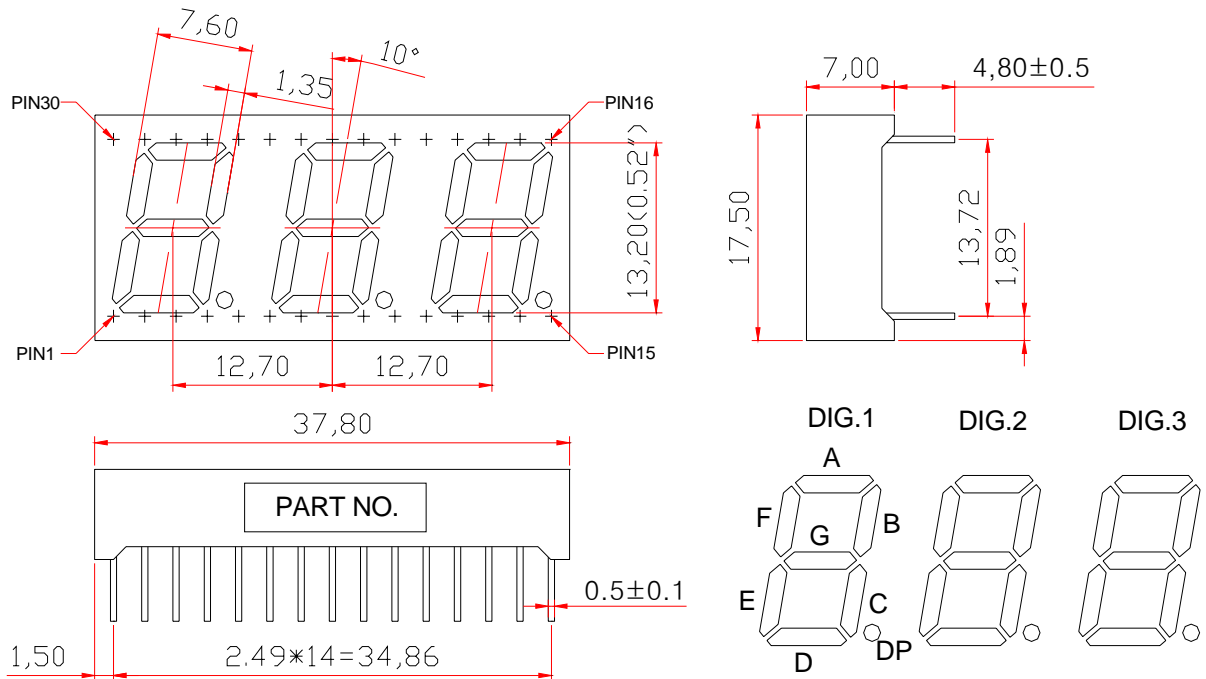

Notes: Unless otherwise stated, The tolerance is  $\pm 0.25$ mm.

## Circuit Diagram:

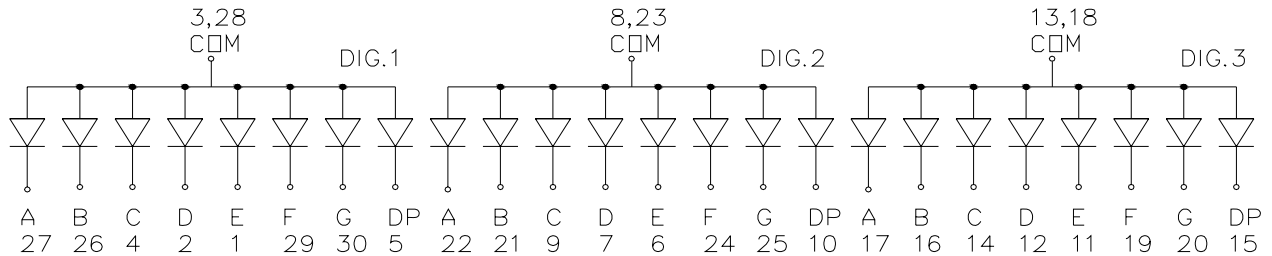

## Pin Connection:

PIN NO.	CONNECTION	PIN NO.	CONNECTION	PIN NO.	CONNECTION
1	Cathode 1E	11	Cathode 3E	21	Cathode 2B
2	Cathode 1D	12	Cathode 3D	22	Cathode 2A
3	Common Anode DIG.1	13	Common Anode DIG.3	23	Common Anode DIG.2
4	Cathode 1C	14	Cathode 3C	24	Cathode 2F
5	Cathode DP1	15	Cathode DP3	25	Cathode 2G
6	Cathode 2E	16	Cathode 3B	26	Cathode 1B
7	Cathode 2D	17	Cathode 3A	27	Cathode 1A
8	Common Anode DIG.2	18	Common Anode DIG.3	28	Common Anode DIG.1
9	Cathode 2C	19	Cathode 3F	29	Cathode 1F
10	Cathode DP2	20	Cathode 3G	30	Cathode 1G

■ **Features:**

- High Reliability
- Color: Bright Red
- Low Power Requirement
- Easy Assembly

■ **Description:**

- Three Digit Display
- Digit Height: 13.2mm(0.52" )
- Black Face and Milky Segment

■ **Absolute Maximum Rating (Ta=25°C):**

Parameter	Symbol	Condition	Color	Rating	Units
Power Dissipation Per Segment	P <sub>d</sub>	—	Red	62.5	mW
Forward Current Per Segment	I <sub>F</sub>	—	Red	25	mA
Peak Forward Current Per Segment	I <sub>FP</sub>	1/10 Duty 10KHz	Red	100	mA
Reverse Voltage Per Segment	V <sub>R</sub>	—	Red	5	V
Operating Temperature Range	T <sub>opr</sub>	—	—	-35~+85	°C
Storage Temperature Range	T <sub>stg</sub>	—	—	-35~+85	°C

■ **Electrical/Optical Characteristics Rating(Ta=25°C)**

Item	Symbol	Test conditions	Location	Rating			Units
				Min.	Typ.	Max.	
Forward Voltage	V <sub>F</sub>	I <sub>F</sub> =20mA	Per Segment	—	2.0	2.50	V
Reverse Current	I <sub>R</sub>	V <sub>R</sub> =5V	Per Segment	—	—	100	μA
Luminous Intensity	I <sub>V</sub>	I <sub>F</sub> =10mA	Per Segment	7201	11500	18000	μcd
Peak Emission Wave Length	λ <sub>P</sub>	I <sub>F</sub> =20mA	Per Segment	—	660	—	nm
	λ <sub>D</sub>			—	640	—	
Spectral Line Half Width	Δλ	I <sub>F</sub> =20mA	Per Segment	—	20	—	nm
Luminous Intensity Matching Ratio (Segment to Segment)	I <sub>v-m</sub>	I <sub>F</sub> =10mA	—	—	—	1.2:1	

■ **Luminous Intensity Sorting: (Luminous Intensity Tolerance is +/-10%)**

Rank	Symbol	Condition	Min	Max	Unit
O	O	I <sub>F</sub> =10mA	7201	8500	μcd
P	P	I <sub>F</sub> =10mA	8501	10500	μcd
Q	Q	I <sub>F</sub> =10mA	10501	12800	μcd
R	R	I <sub>F</sub> =10mA	12801	15250	μcd
S	S	I <sub>F</sub> =10mA	15251	18000	μcd

■ **Soldering Conditions: Soldering Temp. ≤ +260°C, Soldering Time. ≤ 3sec.**  
 (at 2mm Distance from The Case of Reflector Edge)

**Typical Elector-Optical Characteristics Curve:**

**Fig1. Forward Current vs. Forward Voltage:**

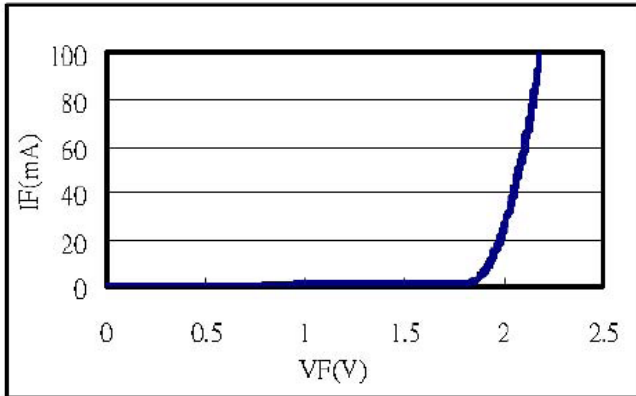

**Fig2. Forward Current vs. Relative Intensity:**

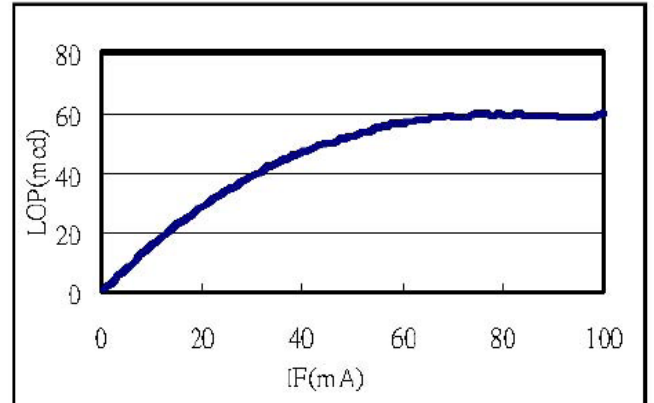

**Fig3. Forward Current vs. Relative Wavelength:**

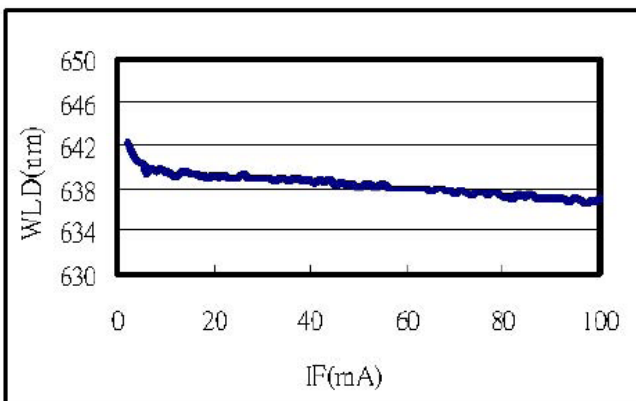

**Fig4. Temperature vs. Relative Intensity:**

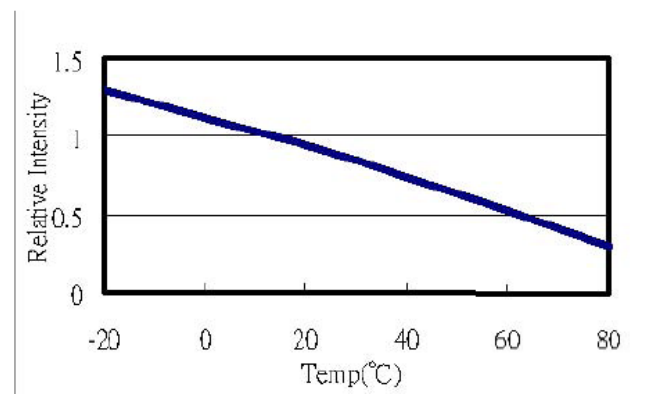

**Fig5. Temperature vs. Relative Wavelength:**

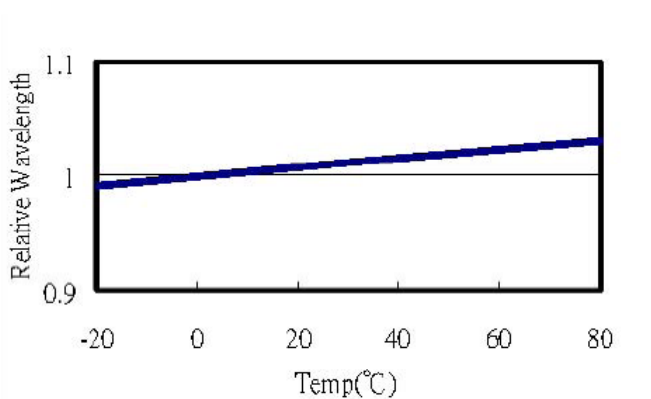

**Fig6. Life Test at 20mA R.T. 1000hrs:**

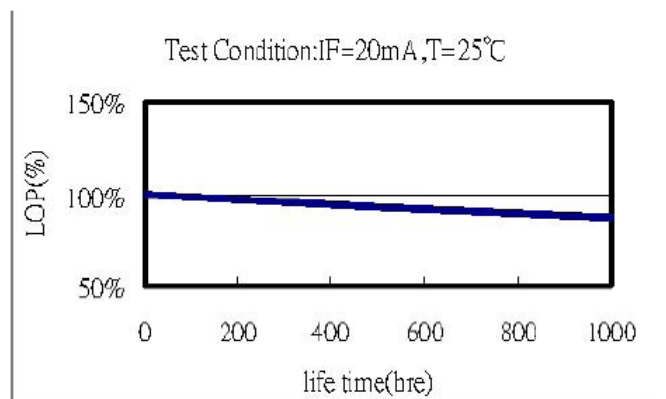

# WCN Opto Group Co., Limited

## ■ LED Displays Reliability Test:

CLASSIFICATION	TEST ITEM	DESCRIPTION AND TEST CONDITION
ENDURANCE TEST	OPERATION LIFE	EVALUATES RESISTANCE OF THE DEVICE WHEN OPERATED AT ELECTRICAL STRESS T <sub>a</sub> = UNDER ROOM TEMPERATURE I <sub>F</sub> = I <sub>F</sub> max
	HIGH TEMPERATURE HIGH HUMIDITY STORAGE	EVALUATES MOISTURE RESISTANCE OF THE DEVICE WHEN STORED FOR A LONG TERM AT HIGH TEMPERATURE AND HUMIDITY T <sub>a</sub> = 65±5°C RH=90~95%RH TEST TIME=240± 2Hrs
	HIGH TEMPERATURE STORAGE	EVALUATES DEVICE DURABILITY FOR LONG TERM STORAGE IN HIGH TEMPERATURE T <sub>a</sub> = 85±5°C(COB: T <sub>a</sub> =65±5°C) TEST TIME=1000Hrs(-24Hrs, +72Hrs)
	LOW TEMPERATURE STORAGE	EVALUATES DEVICE DURABILITY FOR LONG TERM STORAGE IN LOW TEMPERATURE T <sub>a</sub> = -35±5°C TEST TIME=1000Hrs(-24Hrs, +72Hrs)
ENVIRONMENTAL TEST	TEMPERATURE CYCLING	EVALUATES RESISTANCE OF DEVICE AT THERMAL STRESSES OR EXPANSION AND CONTRACTION 85°C ~ 25°C ~ -35°C ~ 25°C 30min 5min 30min 5min 10 CYCLES(COB: T <sub>hot</sub> =65°C, T <sub>cold</sub> =-25°C)
	THERMAL SHOCK	EVALUATES DEVICE STRUCTURE AND STRUCTURE AND MECHANICAL RESISTANCE WHEN SUDDENLY EXPOSED AT SERVE CHANGES 85±5°C ~ -35±5°C 10min 10min 10 CYCLES(COB: T <sub>hot</sub> =65°C, T <sub>cold</sub> =-25°C)
	SOLDERABILITY	EVALUATES SOLDERABILITY ON LEADS OF DEVICE T.SOL=230±5°C DWELL TIME=5±1sec.
	SOLDER RESISTANCE	EVALUATES RESISTANCE TO THERMAL STRESS CAUSED BY SOLDERING T.SOL=260±5°C DWELL TIME=10±1sec.

## ■ Packing method A:

64 pcs / Red Expandable Polyethylene.

440 pcs / Box(360\*175\*130mm).

2640 pcs / Carton(550\*380\*280mm).

## ■ Packing method B:

13pcs / IC Tube.(520\*19.5\*18.6)

702 pcs / Box(537\*175\*125mm).

2808 pcs / Carton(550\*380\*280mm).