

# **WCN3-0030SD-A11**

## **SPECIFICATION**

<b>WCN</b>			<b>CUSTOMER Confirmed</b>
<b>Prepared by</b>	<b>Checked by</b>	<b>Approved by</b>	
<b>Fei</b> <b>2016-6-27</b>	<b>Athena</b>		
<b>REVISION RECORD</b>			

**REVISION: A0**

### Outer Dimension:

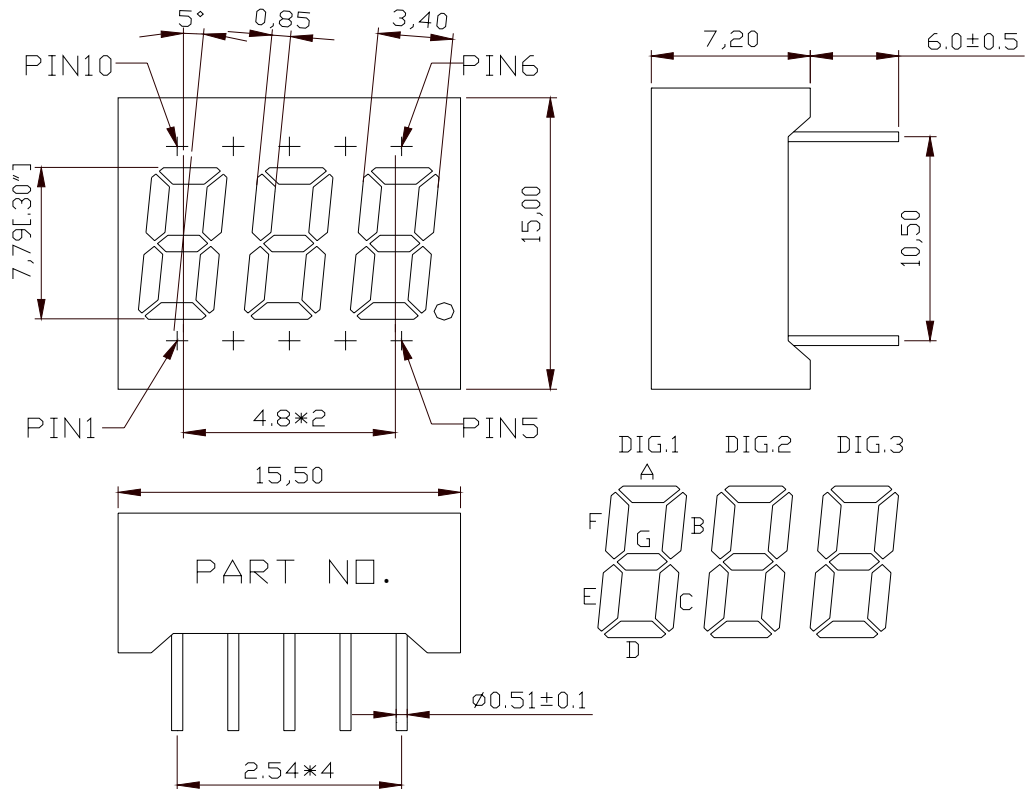

Notes: Unless otherwise stated, The tolerance is  $\pm 0.25\text{mm}$ .

### Circuit Diagram:

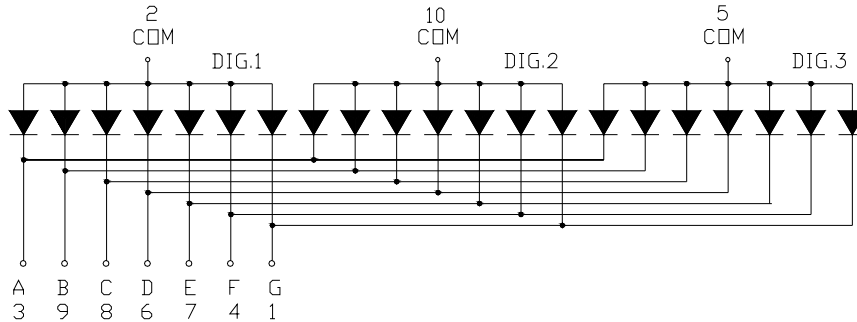

### Pin Connection:

PIN NO.	CONNECTION	PIN NO.	CONNECTION
1	Cathode G	6	Cathode D
2	Common Anode Dig.1	7	Cathode E
3	Cathode A	8	Cathode C
4	Cathode F	9	Cathode B
5	Common Anode Dig.3	10	Common Anode Dig.2

■ **Features:**

- High Reliability
- Color: Bright Red
- Low Power Requirement
- Easy Assembly

■ **Description:**

- Three Digit Display
- Digit Height:7.6mm(0.30" )
- Black Face and Milky Segment

■ **Absolute Maximum Rating (Ta=25°C):**

Parameter	Symbol	Condition	Color	Rating	Units
Power Dissipation Per Segment	P <sub>d</sub>	—	Red	65	mW
Forward Current Per Segment	I <sub>F</sub>	—	Red	25	mA
Peak Forward Current Per Segment	I <sub>FP</sub>	1/10 Duty 10KHz	Red	100	mA
Reverse Voltage Per Segment	V <sub>R</sub>	—	Red	5	V
Operating Temperature Range	T <sub>opr</sub>	—	—	-35~+85	°C
Storage Temperature Range	T <sub>stg</sub>	—	—	-35~+85	°C

■ **Electrical/Optical Characteristics Rating(Ta=25°C)**

Item	Symbol	Test conditions	Location	Rating			Units
				Min.	Typ.	Max.	
Forward Voltage	V <sub>F</sub>	I <sub>F</sub> =20mA	Per Segment	—	2.0	2.60	V
Reverse Current	I <sub>R</sub>	V <sub>R</sub> =5V	Per Segment	—	—	100	μA
Luminous Intensity	I <sub>v</sub>	I <sub>F</sub> =10mA	Per Segment	5001	7800	12800	μcd
Peak Emission Wave Length	λ <sub>P</sub>	I <sub>F</sub> =20mA	Per Segment	—	660	—	nm
	λ <sub>D</sub>			—	640	—	
Spectral Line Half Width	△λ	I <sub>F</sub> =20mA	Per Segment	—	20	—	nm
Luminous Intensity Matching Ratio (Segment to Segment)	I <sub>v-m</sub>	I <sub>F</sub> =10mA	—	—	—	1.2:1	

■ **Luminous Intensity Sorting: (Luminous Intensity Tolerance is +/-10%)**

Rank	Symbol	Condition	Min	Max	Unit
M	M	I <sub>F</sub> =10mA	5001	6100	μcd
N	N	I <sub>F</sub> =10mA	6101	7200	μcd
O	O	I <sub>F</sub> =10mA	7201	8500	μcd
P	P	I <sub>F</sub> =10mA	8501	10500	μcd
Q	Q	I <sub>F</sub> =10mA	10501	12800	μcd

■ **Soldering Conditions: Soldering Temp. ≤+260°C, Soldering Time. ≤3sec.**  
 (at 2mm Distance from The Case of Reflector Edge)

■ **Typical Elector-Optical Characteristics Curve:**

**Fig1. Forward Current vs. Forward Voltage:**

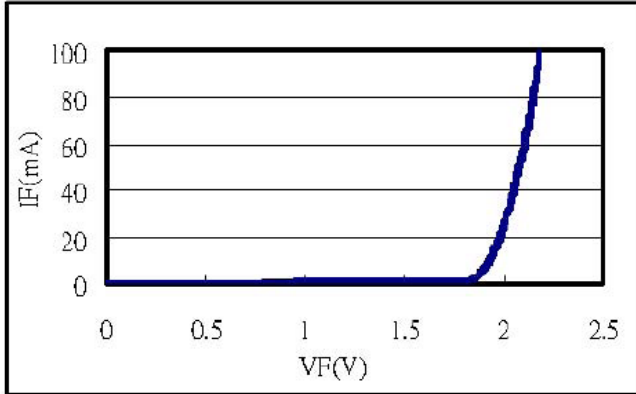

**Fig2. Forward Current vs. Relative Intensity:**

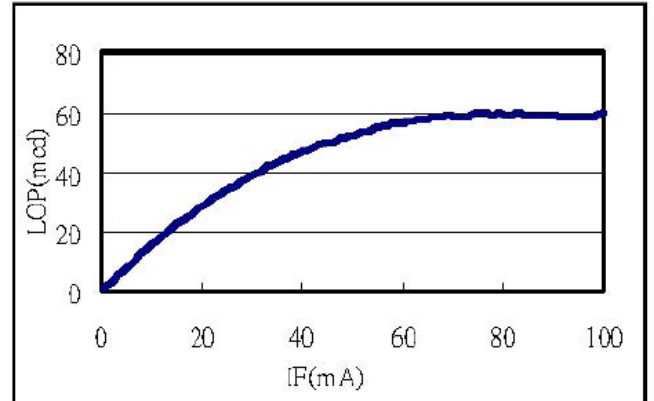

**Fig3. Forward Current vs. Relative Wavelength:**

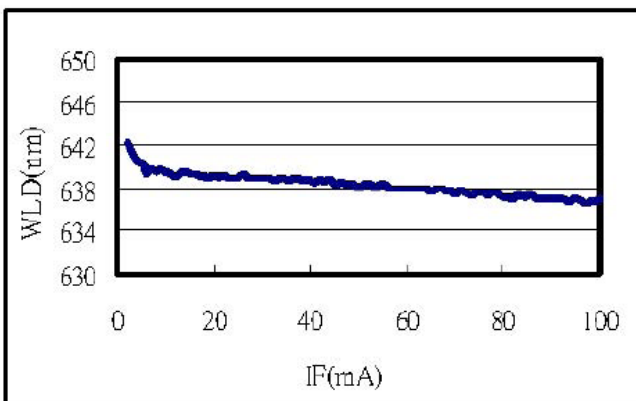

**Fig4. Temperature vs. Relative Intensity:**

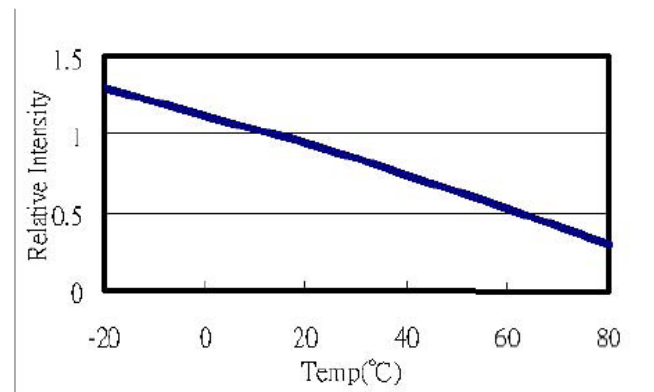

**Fig5. Temperature vs. Relative Wavelength:**

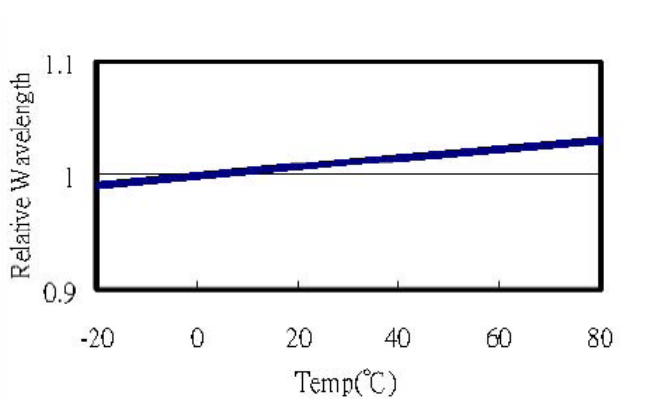

**Fig6. Life Test at 20mA R.T. 1000hrs:**

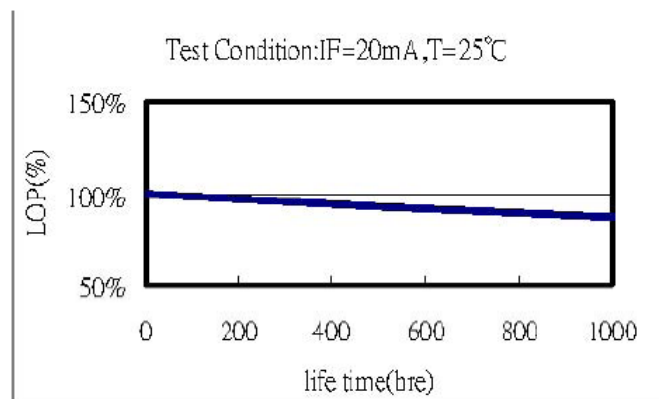

## LED Displays Reliability Test:

CLASSIFICATION	TEST ITEM	DESCRIPTION AND TEST CONDITION
ENDURANCE TEST	OPERATION LIFE	EVALUATES RESISTANCE OF THE DEVICE WHEN OPERATED AT ELECTRICAL STRESS $T_a$ = UNDER ROOM TEMPERATURE $I_F = I_F \text{ max}$
	HIGH TEMPERATURE HIGH HUMIDITY STORAGE	EVALUATES MOISTURE RESISTANCE OF THE DEVICE WHEN STORED FOR A LONG TERM AT HIGH TEMPERATURE AND HUMIDITY $T_a = 65 \pm 5^\circ\text{C}$ RH=90~95%RH TEST TIME=240 $\pm$ 2Hrs
	HIGH TEMPERATURE STORAGE	EVALUATES DEVICE DURABILITY FOR LONG TERM STORAGE IN HIGH TEMPERATURE $T_a = 85 \pm 5^\circ\text{C}$ (COB: $T_a = 65 \pm 5^\circ\text{C}$ ) TEST TIME=1000Hrs(-24Hrs, +72Hrs)
	LOW TEMPERATURE STORAGE	EVALUATES DEVICE DURABILITY FOR LONG TERM STORAGE IN LOW TEMPERATURE $T_a = -35 \pm 5^\circ\text{C}$ TEST TIME=1000Hrs(-24Hrs, +72Hrs)
ENVIRONMENTAL TEST	TEMPERATURE CYCLING	EVALUATES RESISTANCE OF DEVICE AT THERMAL STRESSES OR EXPANSION AND CONTRACTION $85^\circ\text{C} \sim 25^\circ\text{C} \sim -35^\circ\text{C} \sim 25^\circ\text{C}$ 30min 5min 30min 5min 10 CYCLES(COB: $T_{\text{hot}}=65^\circ\text{C}$ , $T_{\text{cold}}=-25^\circ\text{C}$ )
	THERMAL SHOCK	EVALUATES DEVICE STRUCTURE AND STRUCTURE AND MECHANICAL RESISTANCE WHEN SUDDENLY EXPOSED AT SERVE CHANGES $85 \pm 5^\circ\text{C} \sim -35 \pm 5^\circ\text{C}$ 10min 10min 10 CYCLES(COB: $T_{\text{hot}}=65^\circ\text{C}$ , $T_{\text{cold}}=-25^\circ\text{C}$ )
	SOLDERABILITY	EVALUATES SOLDERABILITY ON LEADS OF DEVICE $T_{\text{SOL}}=230 \pm 5^\circ\text{C}$ DWELL TIME=5 $\pm$ 1sec.
	SOLDER RESISTANCE	EVALUATES RESISTANCE TO THERMAL STRESS CAUSED BY SOLDERING $T_{\text{SOL}}=260 \pm 5^\circ\text{C}$ DWELL TIME=10 $\pm$ 1sec.

### Packing method A:

200 pcs / Red Expandable Polyethylene.

1200 pcs / Box(360\*175\*130mm).

7200 pcs / Catton(550\*380\*280mm).

### Packing method B:

33 pcs / IC Tube.

2310 pcs / Box(537\*175\*125mm).

9240 pcs / Catton(550\*380\*280mm).