

WCN2-00A0HY-A21S

SPECIFICATION

WCN			CUSTOMER Confirmed
Prepared by	Checked by	Approved by	
Fei 2016-6-6	Athena		
REVISION RECORD			

**REVISION: A0**

Outer Dimension:

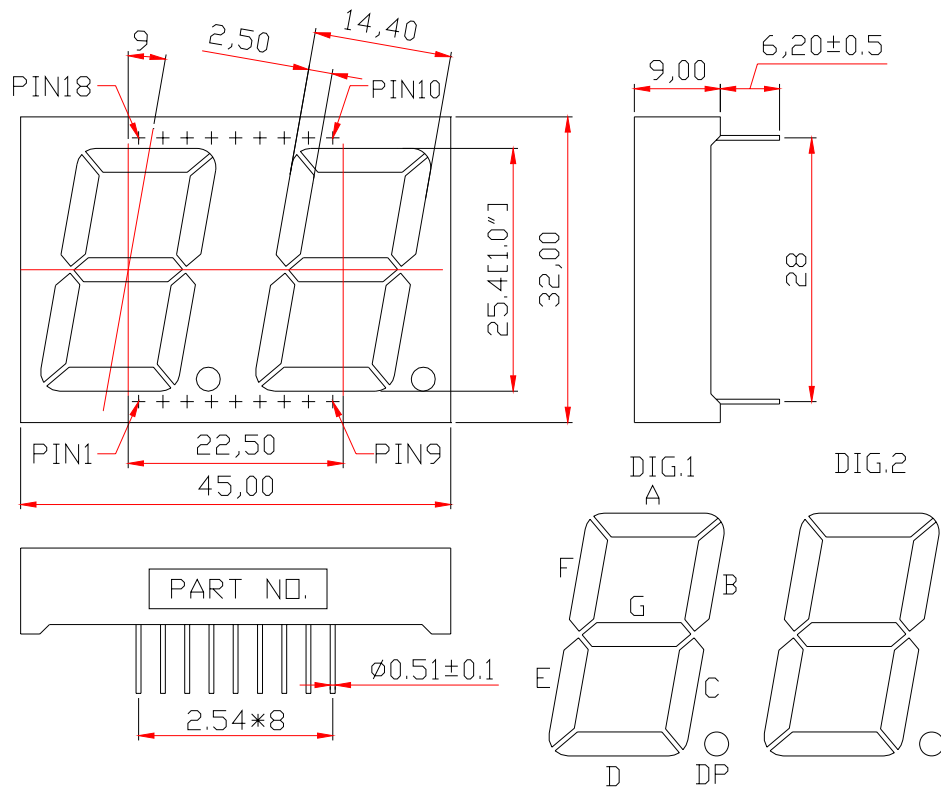

Notes: Unless otherwise stated, The tolerance is $\pm 0.25\text{mm}$.

Circuit Diagram:

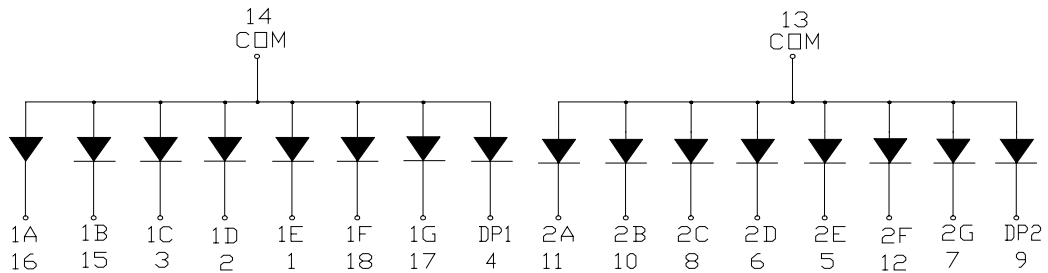

Pin Connection:

PIN NO.	CONNECTION	PIN NO.	CONNECTION
1	Cathode 1E	10	Cathode 2B
2	Cathode 1D	11	Cathode 2A
3	Cathode 1C	12	Cathode 2F
4	Cathode DP1	13	Common Anode Dig.2
5	Cathode 2E	14	Common Anode Dig.1
6	Cathode 2D	15	Cathode 1B
7	Cathode 2G	16	Cathode 1A
8	Cathode 2C	17	Cathode 1G
9	Cathode DP2	18	Cathode 1F

■ **Features:**

- High Reliability
- Color: Bright Yellow
- Low Power Requirement
- Easy Assembly

■ **Description:**

- Dual Digit LED Display
- Digit Height:25.4mm(1.0")
- Black Face and Milky Segment

■ **Absolute Maximum Rating (Ta=25°C):**

Parameter	Symbol	Condition	Color	Rating	Units
Power Dissipation Per Segment	P _d	—	Yellow	65	mW
Forward Current Per Segment	I _F	—	Yellow	25	mA
Peak Forward Current Per Segment	I _{FP}	1/10 Duty 10KHz	Yellow	100	mA
Reverse Voltage Per Segment	V _R	—	Yellow	5	V
Operating Temperature Range	T _{opr}	—	—	-35~+85	°C
Storage Temperature Range	T _{stg}	—	—	-35~+85	°C

■ **Electrical/Optical Characteristics Rating(Ta=25°C)**

Item	Symbol	Test conditions	Location	Rating			Units
				Min.	Typ.	Max.	
Forward Voltage	V _F	I _F =20mA	Per Segment	—	2.0	2.6	V
Reverse Current	I _R	V _R =5V	Per Segment	—	—	100	μA
Luminous Intensity	I _V	I _F =10mA	Per Segment	10501	16500	26000	μcd
Peak Emission Wave Length	λ _P	I _F =20mA	Per Segment	—	593	—	nm
	λ _D			—	588	—	
Spectral Line Half Width	△λ	I _F =20mA	Per Segment	—	30	—	nm
Luminous Intensity Matching Ratio (Segment to Segment)	I _{v-m}	I _F =20mA	—	—	—	1.2:1	

■ **Luminous Intensity Sorting: (Luminous Intensity Tolerance is +/-10%)**

Rank	Symbol	Condition	Min	Max	Unit
Q	Q	I _F =10mA	10501	12800	μcd
R	R	I _F =10mA	12801	15250	μcd
S	S	I _F =10mA	15251	18000	μcd
T	T	I _F =10mA	18001	21500	μcd
U	U	I _F =10mA	21501	26000	μcd

■ **Soldering Conditions: Soldering Temp. ≤+260°C, Soldering Time. ≤3sec.**
(at 2mm Distance from The Case of Reflector Edge)

■ Typical Elector-Optical Characteristics Curve:

Fig 1. Forward Current vs. Forward Voltage

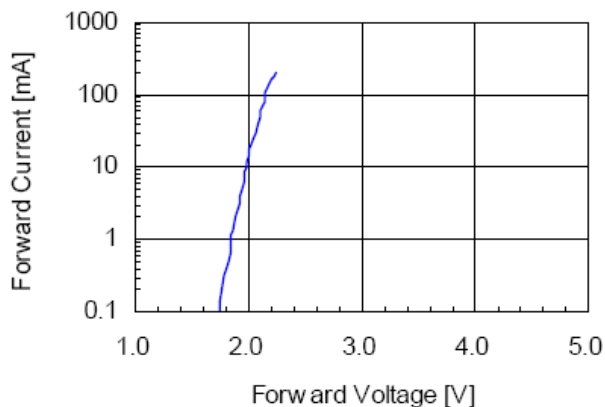

Fig 2. Relative Intensity vs. Forward Current

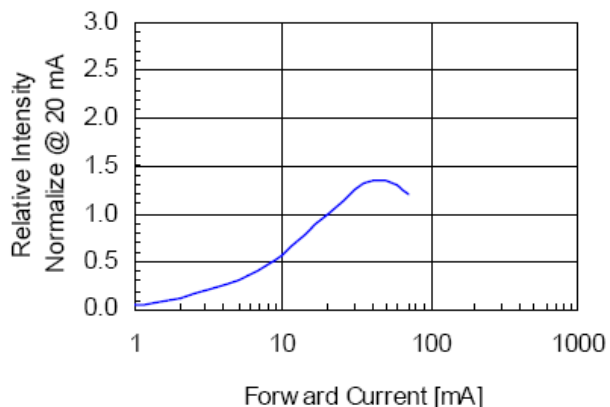

Fig 3. Forward Voltage vs. Temperature

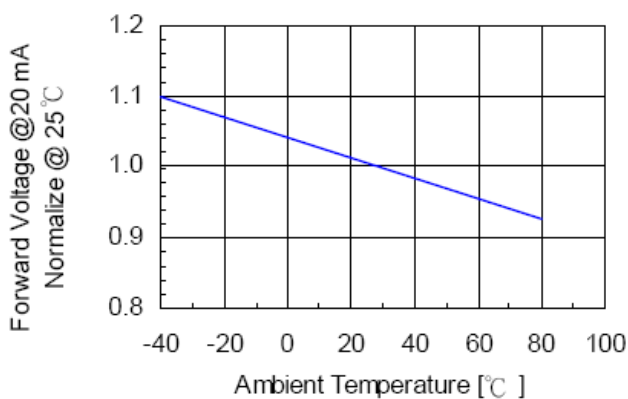

Fig 4. Relative Intensity vs. Temperature

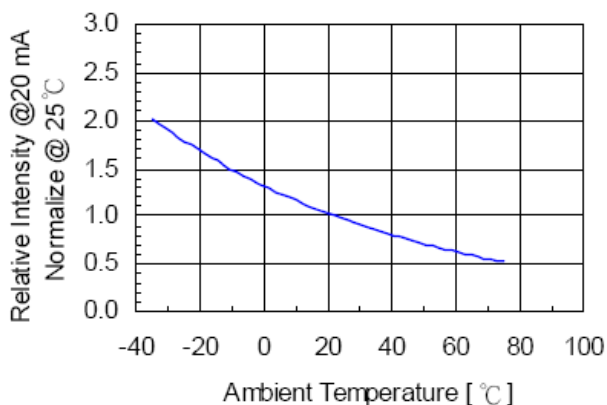
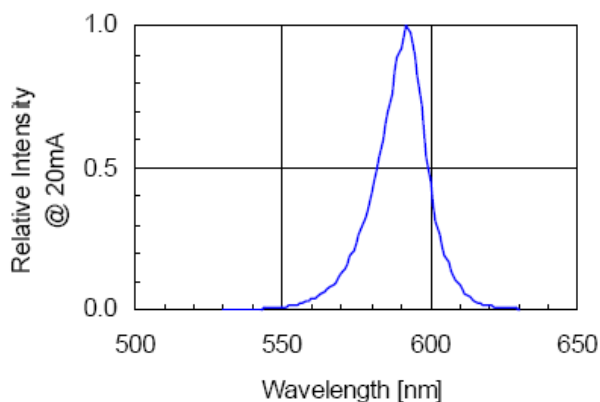

Fig 5. Relative Intensity vs. Wavelength



LED Displays Reliability Test:

CLASSIFICATION	TEST ITEM	DESCRIPTION AND TEST CONDITION
ENDURANCE TEST	OPERATION LIFE	EVALUATES RESISTANCE OF THE DEVICE WHEN OPERATED AT ELECTRICAL STRESS T _a = UNDER ROOM TEMPERATURE I _F = I _F max
	HIGH TEMPERATURE HIGH HUMIDITY STORAGE	EVALUATES MOISTURE RESISTANCE OF THE DEVICE WHEN STORED FOR A LONG TERM AT HIGH TEMPERATURE AND HUMIDITY T _a = 65±5°C RH=90~95%RH TEST TIME=240± 2Hrs
	HIGH TEMPERATURE STORAGE	EVALUATES DEVICE DURABILITY FOR LONG TERM STORAGE IN HIGH TEMPERATURE T _a = 85±5°C(COB: T _a =65±5°C) TEST TIME=1000Hrs(-24Hrs, +72Hrs)
	LOW TEMPERATURE STORAGE	EVALUATES DEVICE DURABILITY FOR LONG TERM STORAGE IN LOW TEMPERATURE T _a = -35±5°C TEST TIME=1000Hrs(-24Hrs, +72Hrs)
ENVIRONMENTAL TEST	TEMPERATURE CYCLING	EVALUATES RESISTANCE OF DEVICE AT THERMAL STRESSES OR EXPANSION AND CONTRACTION 85°C ~ 25°C ~ -35°C ~ 25°C 30min 5min 30min 5min 10 CYCLES(COB: T _{hot} =65°C, T _{cold} =-25°C)
	THERMAL SHOCK	EVALUATES DEVICE STRUCTURE AND STRUCTURE AND MECHANICAL RESISTANCE WHEN SUDDENLY EXPOSED AT SERVE CHANGES 85±5°C ~ -35±5°C 10min 10min 10 CYCLES(COB: T _{hot} =65°C, T _{cold} =-25°C)
	SOLDERABILITY	EVALUATES SOLDERABILITY ON LEADS OF DEVICE T.SOL=230±5°C DWELL TIME=5±1sec.
	SOLDER RESISTANCE	EVALUATES RESISTANCE TO THERMAL STRESS CAUSED BY SOLDERING T.SOL=260±5°C DWELL TIME=10±1sec.

Packing method A:

30pcs / Red Expandable Polyethylene.

150 pcs / Box(360*175*130mm).

900 pcs / Carton(550*380*280mm).

Packing method B:

11 pcs / IC Tube(520*37*21).

264 pcs / Box(537*175*125mm).

1056 pcs / Carton(550*380*280mm)