

WCN1-0039SR-A21**SPECIFICATION**

WCN			CUSTOMER Confirmed
Prepared by	Checked by	Approved by	
Liu	Athena	William	
REVISION RECORD			



REVISION: A0

■ **Outer Dimension:**

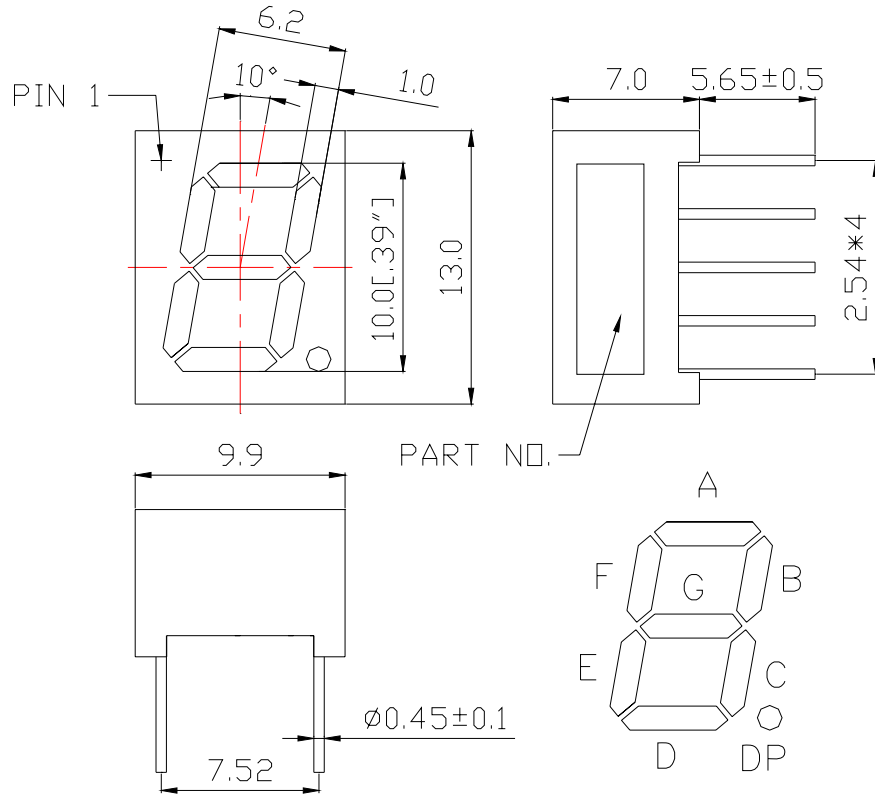

Notes: Unless otherwise stated, the tolerance is ± 0.25 mm.

■ **Circuit Diagram:**

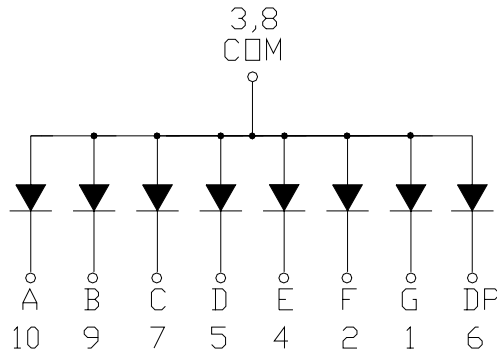

■ **Pin Connection:**

PIN NO.	CONNECTION	PIN NO.	CONNECTION
1	Cathode G	6	Cathode DP
2	Cathode F	7	Cathode C
3	Common Anode	8	Common Anode
4	Cathode E	9	Cathode B
5	Cathode D	10	Cathode A

■ **Features:**

- High Reliability
- Color: Red
- Low Power Requirement
- Easy Assembly

■ **Description:**

- Single Digit LED Display
- Digit Height: 10.0mm (0.39")
- Black Face and Milky Segment

■ **Absolute Maximum Rating (Ta=25°C):**

Parameter	Symbol	Condition	Color	Rating	Units
Power Dissipation Per Segment	P _d	—	Red	65	mW
Forward Current Per Segment	I _F	—	Red	25	mA
Peak Forward Current Per Segment	I _{FP}	1/10 Duty 10KHz	Red	100	mA
Reverse Voltage Per Segment	V _R	—	Red	5	V
Operating Temperature Range	T _{opr}	—	—	-35~+85	°C
Storage Temperature Range	T _{stg}	—	—	-35~+85	°C

■ **Electrical/Optical Characteristics Rating(Ta=25°C)**

Item	Symbol	Test conditions	Location	Rating			Units
				Min.	Typ.	Max.	
Forward Voltage	V _F	I _F =20mA	Per Segment	—	2.00	2.60	V
Reverse Current	I _R	V _R =5V	Per Segment	—	—	100	μA
Luminous Intensity	I _V	I _F =10mA	Per Segment	3051	5500	—	μcd
Peak Emission Wave Length	λ _P	I _F =20mA	Per Segment	—	638	—	nm
	λ _D				633		
Spectral Line Half Width	△λ	I _F =20mA	Per Segment	—	20	—	nm
Luminous Intensity Matching Ratio (Segment to Segment)	I _{v-m}	I _F =10mA	—	—	—	2:1	

■ **Luminous Intensity Sorting: (Luminous Intensity Tolerance is +/-10%)**

Rank	Symbol	Condition	Min	Max	Unit
K	K	I _F =10mA	3051	4000	μcd
L	L	I _F =10mA	4001	5000	μcd
M	M	I _F =10mA	5001	6100	μcd
N	N	I _F =10mA	6101	7200	μcd
O	O	I _F =10mA	7201	8500	μcd

■ **Soldering Conditions:** Soldering Temp. ≤+260°C, Soldering Time. ≤3sec.
(at 2mm Distance from The Case of Reflector Edge)

■ **Typical Electro-Optical Characteristics Curve:**

Fig 1. Forward Current vs. Forward Voltage

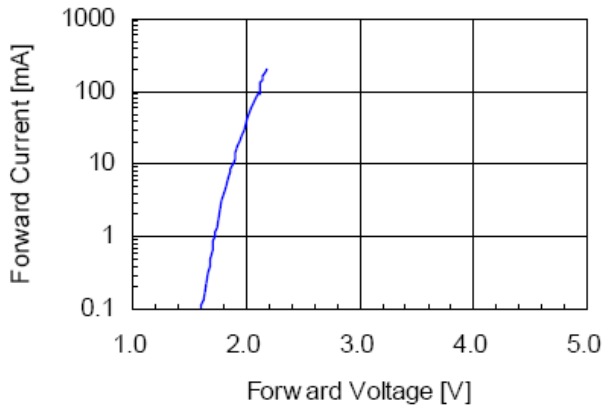

Fig 2. Relative Intensity vs. Forward Current

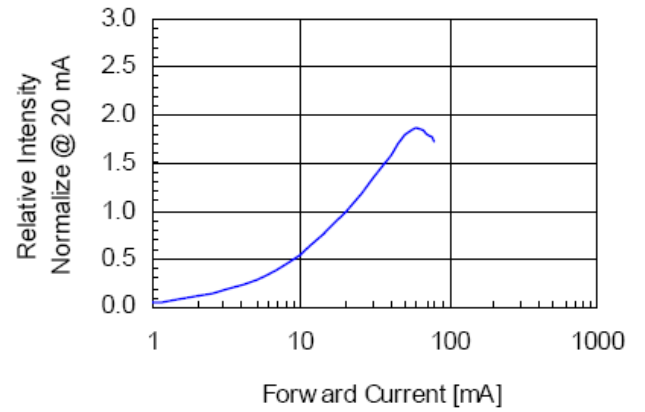

Fig 3. Forward Voltage vs. Temperature

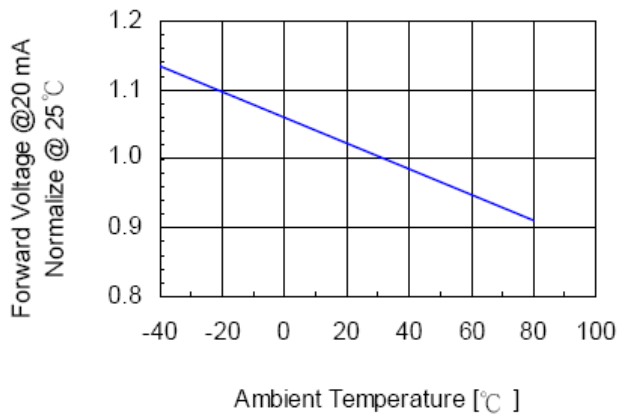

Fig 4. Relative Intensity vs. Temperature

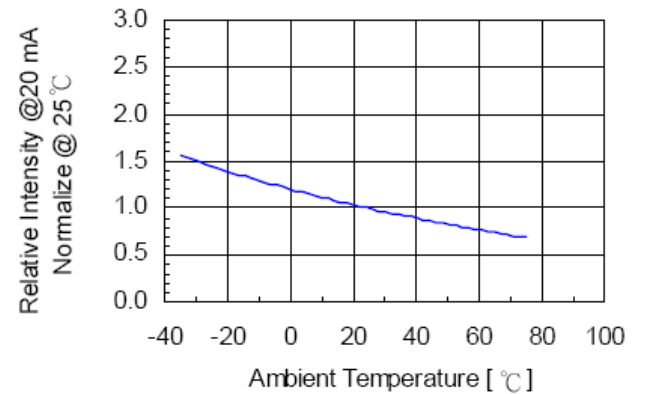
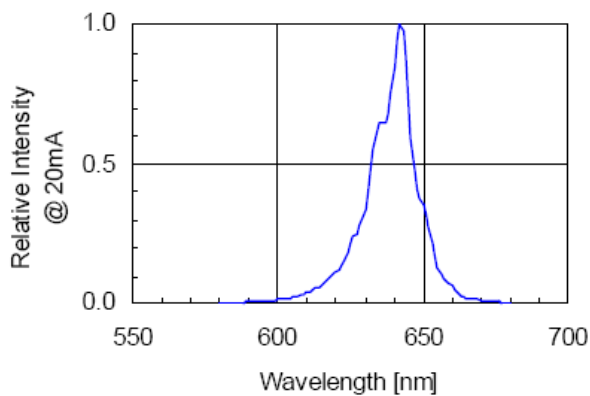

Fig 5. Relative Intensity vs. Wavelength



■ LED Displays Reliability Test:

CLASSIFICATION	TEST ITEM	DESCRIPTION AND TEST CONDITION
ENDURANCE TEST	OPERATION LIFE	EVALUATES RESISTANCE OF THE DEVICE WHEN OPERATED AT ELECTRICAL STRESS T _a = UNDER ROOM TEMPERATURE I _F = I _F max
	HIGH TEMPERATURE HIGH HUMIDITY STORAGE	EVALUATES MOISTURE RESISTANCE OF THE DEVICE WHEN STORED FOR A LONG TERM AT HIGH TEMPERATURE AND HUMIDITY T _a = 65±5°C RH=90~95%RH TEST TIME=240± 2Hrs
	HIGH TEMPERATURE STORAGE	EVALUATES DEVICE DURABILITY FOR LONG TERM STORAGE IN HIGH TEMPERATURE T _a = 85±5°C(COB: T _a =65±5°C) TEST TIME=1000Hrs(-24Hrs, +72Hrs)
	LOW TEMPERATURE STORAGE	EVALUATES DEVICE DURABILITY FOR LONG TERM STORAGE IN LOW TEMPERATURE T _a = -35±5°C TEST TIME=1000Hrs(-24Hrs, +72Hrs)
ENVIRONMENTAL TEST	TEMPERATURE CYCLING	EVALUATES RESISTANCE OF DEVICE AT THERMAL STRESSES OR EXPANSION AND CONTRACTION 85°C ~ 25°C ~ -35°C ~ 25°C 30min 5min 30min 5min 10 CYCLES(COB: T _{hot} =65°C, T _{cold} =-25°C)
	THERMAL SHOCK	EVALUATES DEVICE STRUCTURE AND STRUCTURE AND MECHANICAL RESISTANCE WHEN SUDDENLY EXPOSED AT SERVE CHANGES 85±5°C ~ -35±5°C 10min 10min 10 CYCLES(COB: T _{hot} =65°C, T _{cold} =-25°C)
	SOLDERABILITY	EVALUATES SOLDERABILITY ON LEADS OF DEVICE T.SOL=230±5°C DWELL TIME=5±1sec.
	SOLDER RESISTANCE	EVALUATES RESISTANCE TO THERMAL STRESS CAUSED BY SOLDERING T.SOL=260±5°C DWELL TIME=10±1sec.

■ Package Pattern 1:

350pcs / Red Expandable Polyethylene.

2100pcs / Box(360*175*130mm).

12600pcs / Carton(550*380*280mm).

■ Package Pattern 2:

39pcs / IC Tube.

3003pcs / Box(537*175*125mm).

12012pcs / Carton(550*380*280mm).