

**WCN-5050UV-0E-380****SPECIFICATION**

| WCN                 |                        |   | CUSTOMER<br>Confirmed |
|---------------------|------------------------|---|-----------------------|
| Prepared by         | Checked by             | Approved by   |                       |
| LiuGuo<br>2018-11-9 | ZhangChun<br>2018-11-9 |  |                       |



**Description**

- ◆ Viewing angle:120 deg
- ◆ The materials of the LED dice is InGaN
- ◆ 5.0mm×5.0mm×1.05mm
- ◆ RoHS compliant lead-free soldering compatible

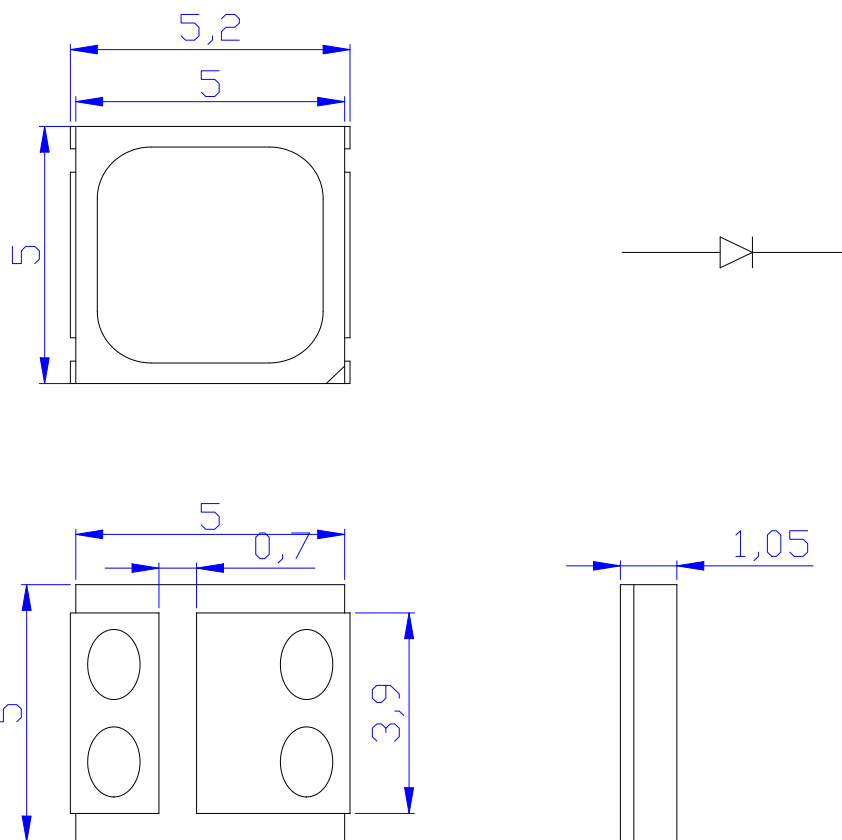
**Package Outline****NOTES:**

1. All dimensions units are millimeters ;
2. All dimensions tolerances are  $\pm 0.2\text{mm}$  unless otherwise noted.

## Absolute Maximum Ratings at Ta=25°C

| Parameter               | Symbol | Rating    | Units |
|-------------------------|--------|-----------|-------|
| Power Dissipation       | Pd     | 204       | mW    |
| Forward current         | IF     | 60        | mA    |
| Peak Forward Current    | IFP    | 200       | mA    |
| Reverse voltage         | VR     | 5         | V     |
| Electrostatic Discharge | ESD    | 1000      | V     |
| Operating temperature   | Topr   | -30~+85   | °C    |
| Storage temperature     | Tstg   | -40 ~+100 | °C    |

## Electrical/Optical characteristics at Ta=25°C

| Item                     | test condition | Symbol         | Value |      |      | Unit    |
|--------------------------|----------------|----------------|-------|------|------|---------|
|                          |                |                | Min.  | Typ. | Max. |         |
| Forward voltage          | If=60mA        | Vf             | 2.8   | --   | 3.0  | V       |
|                          |                |                | 3.0   | --   | 3.2  | V       |
|                          |                |                | 3.2   | --   | 3.4  | V       |
| Radiant Intensity        | If=60mA        | IE             | 25    | --   | 35   | mW/sr   |
| Peak Emission Wavelength | If=60mA        | $\lambda_p$    | 380   | --   | 385  | nm      |
| Reverse current          | Vr=5V          | Ir             | --    | --   | 10   | $\mu$ A |
| Viewing angle at 50% Iv  | If=60mA        | 2 $\theta$ 1/2 | --    | 120  | --   | Deg     |

### NOTE:

- 1.1/10 Duty cycle, 0.1ms pulse width.
2. The above forward voltage measurement allowance tolerance is 0.1V.
3. the above luminous intensity measurement allowance tolerance  $\pm 10\%$ .

## Optical characteristics curves

### Forward Current VS Forward Voltage

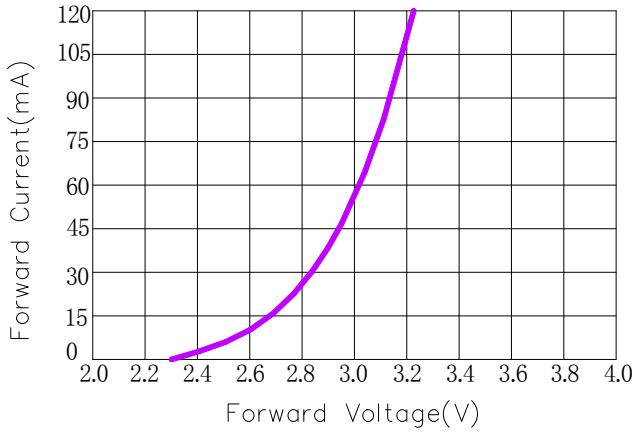

### Relative Flux VS Forward Current

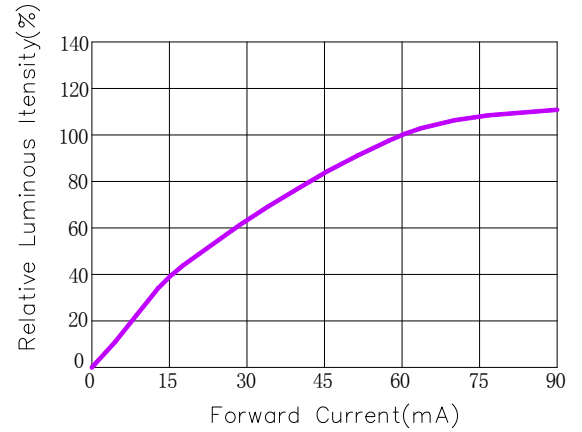

### Relative Flux VS Ambient Temperature

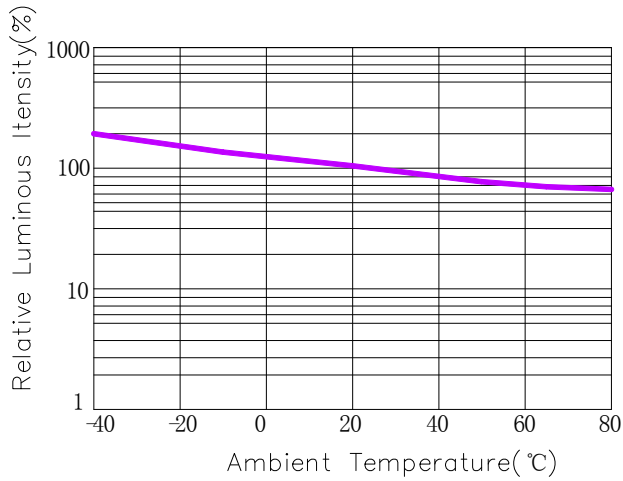

### Forward Current VS Ambient Temperature

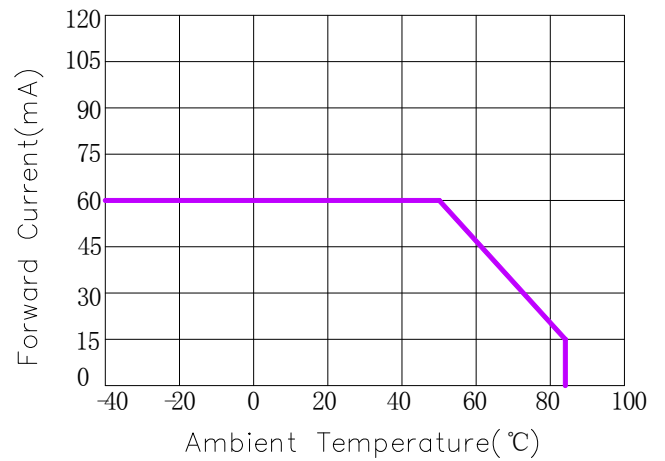

### Relative Spectral Distribution

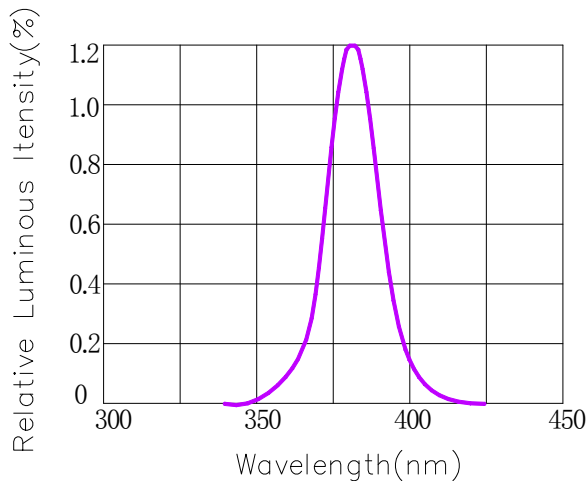

### Typical Spectral Distribution

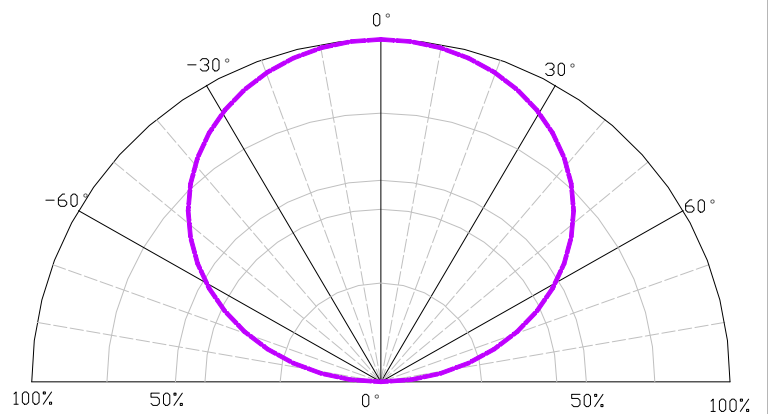

## Packaging Specifications

### Carrier Tape Dimensions

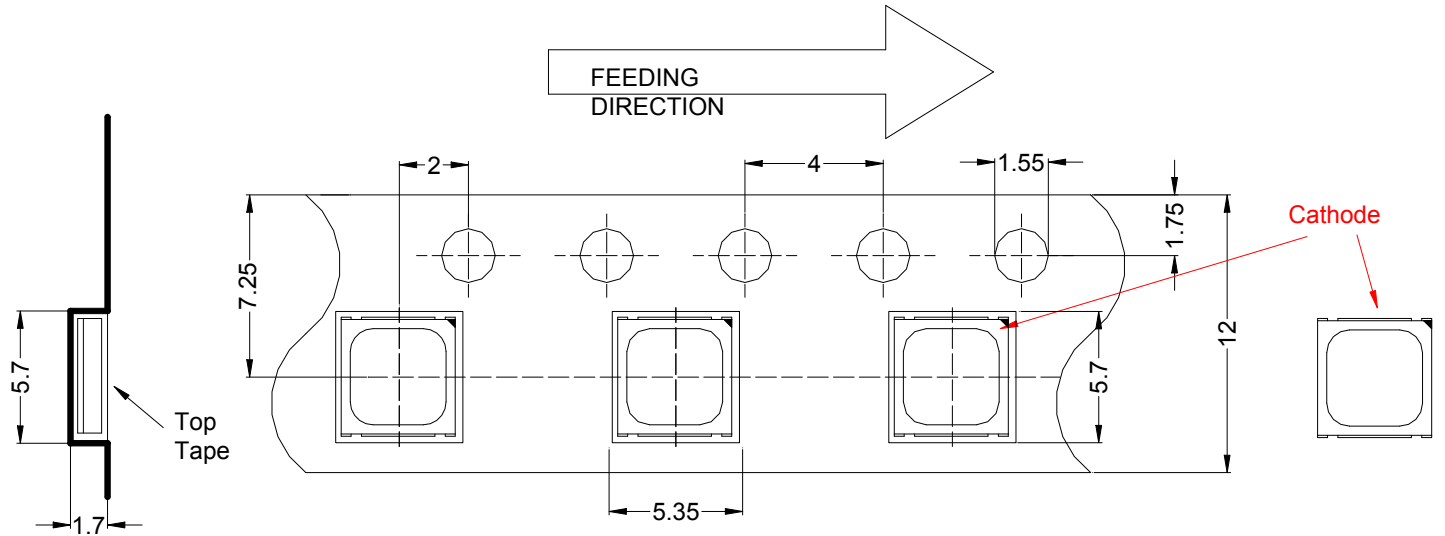

### Reel Dimension

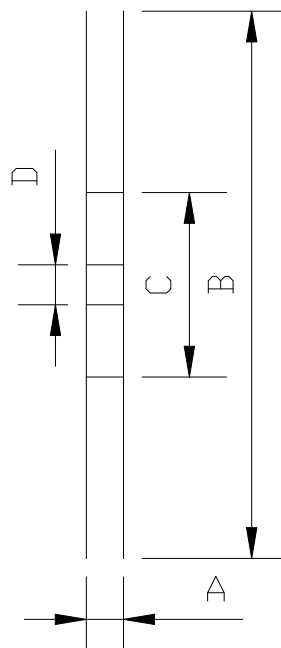
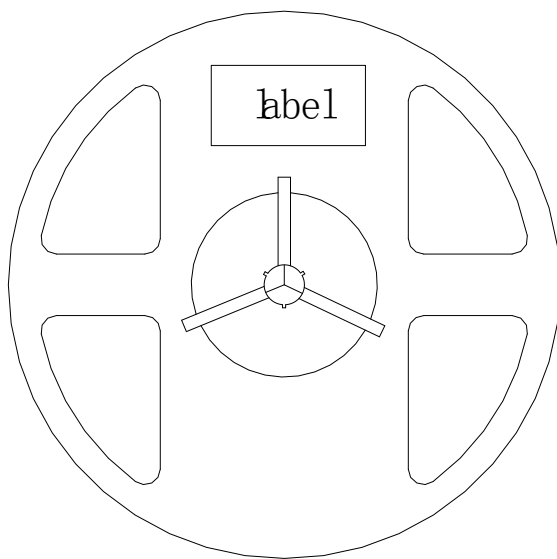

|   |            |
|---|------------|
| A | 16.2±0.1mm |
| B | 178±1mm    |
| C | 60±1mm     |
| D | 21.0±0.5mm |

### NOTE:

1. The tolerances unless mentioned  $\pm 0.1$ mm. Unit : mm
2. 1,000 pcs/Reel.

## Label Form Specification

WCN Opto Group Co., Ltd

P/N: ROHS

QTY: PCS IV:

LOT NO: WL:

MADE IN CHINA

|        |                          |
|--------|--------------------------|
| P/N    | Part Number              |
| QTY    | Packing Quantity         |
| LOT NO | Made Date                |
| IV     | Luminous intensity       |
| WL     | Peak Emission Wavelength |
| VF     | Forward Voltage          |

## Moisture Resistant Packing Process



## Test items and results of reliability

| Type                   | Test Item                    | Test Conditions                   | Note      | Number of Damaged |
|------------------------|------------------------------|-----------------------------------|-----------|-------------------|
| Environmental Sequence | Reflow                       | Ta=260°C max<br>T=10s             | 2 times   | 0/22              |
|                        | Temperature Cycle            | -40°C 30min<br>↑↓<br>100°C 30min  | 100 cycle | 0/22              |
|                        | Thermal Shock                | -40°C 15min<br>↑↓<br>100°C 15min  | 100 cycle | 0/22              |
|                        | High Humidity Heat Cycle     | 30°C ⇔ 65°C<br>90%RH 24hrs/1cycle | 10 cycle  | 0/22              |
|                        | High Temperature Storage     | Ta=100°C                          | 1000 hrs  | 0/22              |
|                        | Low Temperature Storage      | Ta=-40°C                          | 1000 hrs  | 0/22              |
|                        | Humidity Heat Storage        | Ta=60°C<br>RH=90%                 | 1000 hrs  | 0/22              |
|                        | Low Temperature Storage      | Ta=-30°C                          | 1000 hrs  | 0/22              |
| Operation Sequence     | Life Test                    | Ta=25°C<br>IF=20mA                | 1000 hrs  | 0/22              |
|                        | High Humidity Heat Life Test | 60°C RH=90%<br>IF=10mA            | 500 hrs   | 0/22              |
|                        | Low Temperature Life Test    | Ta=-20°C<br>IF=20mA               | 1000 hrs  | 0/22              |

## Reflow Profile

### ■ Reflow Temp/Time



### Notes:

1. We recommend the reflow temperature 245°C (±5°C). the maximum soldering temperature should be limited to 260°C.
2. Don't cause stress to the epoxy resin while it is exposed to high temperature.
3. Number of reflow process shall be 2 times or less.

### ■ Soldering iron

Basic spec is  $\leq 5\text{sec}$  when 260°C. If temperature is higher, time should be shorter (+10°C → -1sec). Power dissipation of iron should be smaller than 20W, and temperatures should be controllable. Surface temperature of the device should be under 230°C.

### ■ Rework

1. Customer must finish rework within 5 sec under 260°C.
2. The head of iron can not touch copper foil
3. Twin-head type is preferred.



■ Avoid rubbing or scraping the resin by any object, during high temperature, for example reflow solder etc.



**Test circuit and handling precautions**

## ■ Test circuit



## ■ Handling precautions

## 1. Over-current-proof

Customer must apply resistors for protection; otherwise slight voltage shift will cause big current change (Burn out will happen).

## 2. Storage

2.1 It is recommended to store the products in the following conditions:

Humidity: 60% R.H. Max.

Temperature : 5°C~30°C (41°F~86°F)

2.2 Shelf life in sealed bag: 12 month at <5°C~30°C and <30% R.H. After the package is

Opened, the products should be used within a week or they should be keeping to stored at  $\leq 20$  R.H. with zip-lock sealed.

## 3. Baking

It is recommended to baking before soldering when the pack is unsealed after 72hrs. The Conditions are as followings:

3.1 70 $\pm$ 3°C x(12~24hrs) and <5%RH, taped reel type

3.2 100 $\pm$ 3°C x(45min~1hr), bulk type

3.3 130 $\pm$ 3°C x(15~30min), bulk type