

WCN-3020HR-120-8E**SPECIFICATION**

WCN			CUSTOMER Confirmed
Prepared by	Checked by	Approved by	
LiuGuo 2018-11-9	ZhangChun 2018-11-9		



Description

- ◆ Viewing angle:120 deg
- ◆ The materials of the LED dice is AlGaInP
- ◆ 3.0mm×2.0mm×1.3mm
- ◆ RoHS compliant lead-free soldering compatible

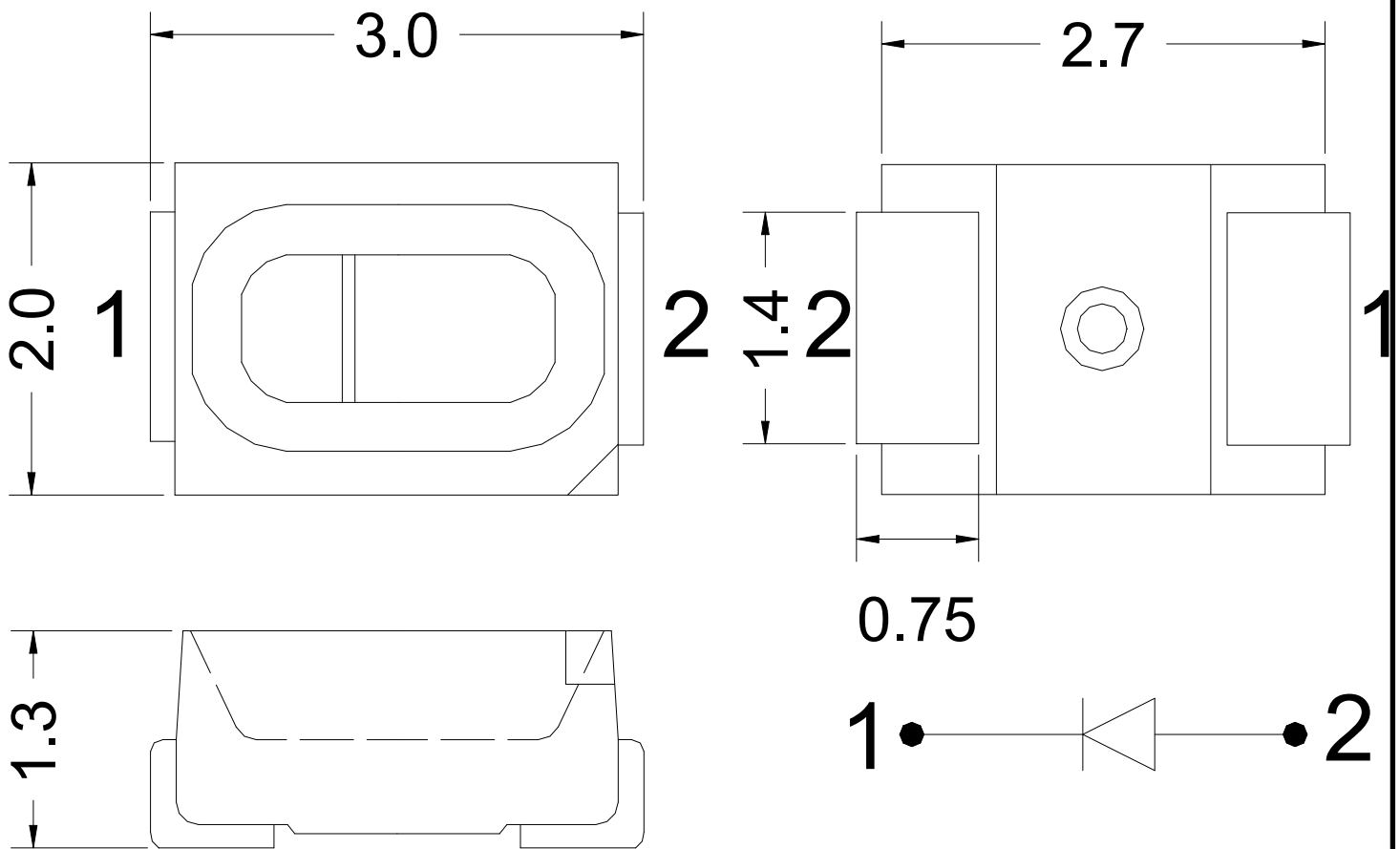
Package Outline**NOTES:**

1. All dimensions units are millimeters ;
2. All dimensions tolerances are $\pm 0.2\text{mm}$ unless otherwise noted.

Absolute Maximum Ratings at Ta=25°C

Parameter	Symbol	Rating	Units
Power Dissipation	Pd	72	mW
Forward current	IF	30	mA
Peak Forward Current	IFP	100	mA
Reverse voltage	VR	5	V
Electrostatic Discharge	ESD	1000	V
Operating temperature	Topr	-30~+85	°C
Storage temperature	Tstg	-40 ~+100	°C
junction temperature	Tj	95	°C

Electrical/Optical characteristics at Ta=25°C

Item	test condition	Symbol	Value			Unit
			Min.	Typ.	Max.	
Forward voltage	If=20mA	Vf	1.8	--	2.0	V
			2.0	--	2.2	V
			2.2	--	2.4	V
Luminous intensity	If=20mA	Iv	400	--	500	mcd
			500	--	600	mcd
			600	--	800	mcd
Dominant wavelength	If=20mA	λd	615	--	620	nm
			620	--	625	nm
			625	--	630	nm
Reverse current	Vr=5V	Ir	--	--	10	μA
Viewing angle at 50% Iv	If=20mA	2 θ1/2	--	120	--	Deg

NOTE:

- 1.1/10 Duty cycle, 0.1ms pulse width.
2. The above forward voltage measurement allowance tolerance is 0.1V.
3. the above luminous intensity measurement allowance tolerance ±10%.

Optical characteristics curves

Forward Current VS Forward Voltage

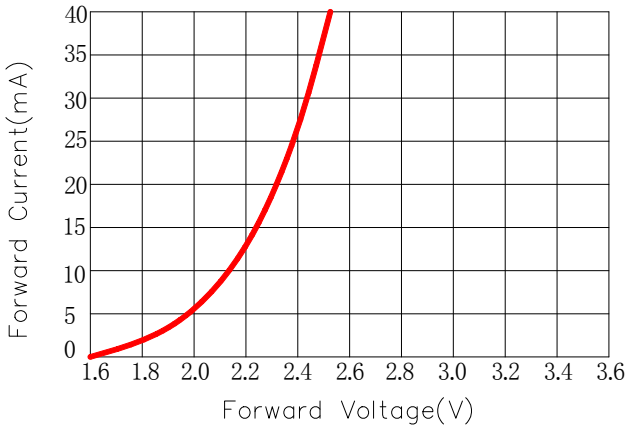

Relative Flux VS Forward Current

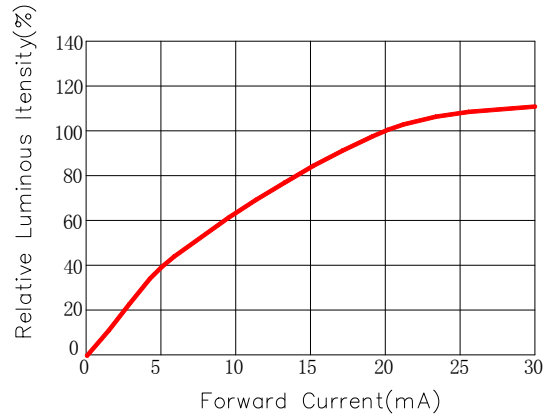

Relative Flux VS Ambient Temperature

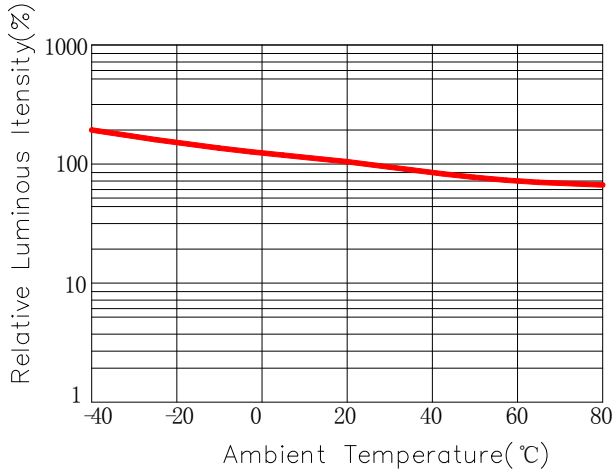

Forward Current VS Ambient Temperature

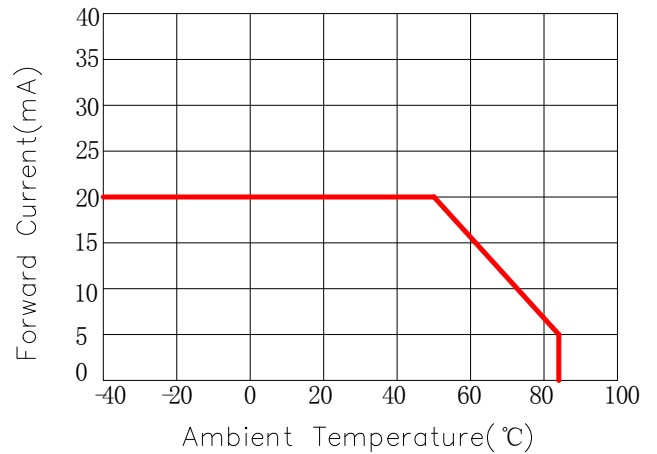

Relative Spectral Distribution

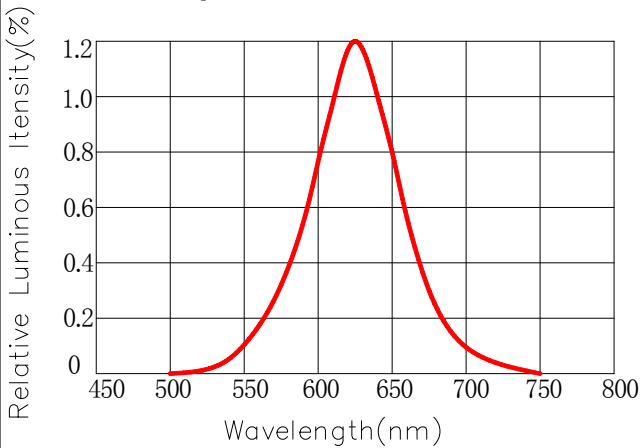

Typical Spectral Distribution

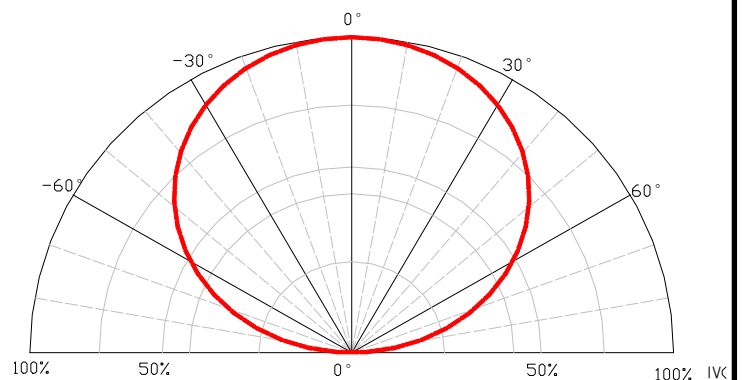

Packaging Specifications

Carrier Tape Dimensions

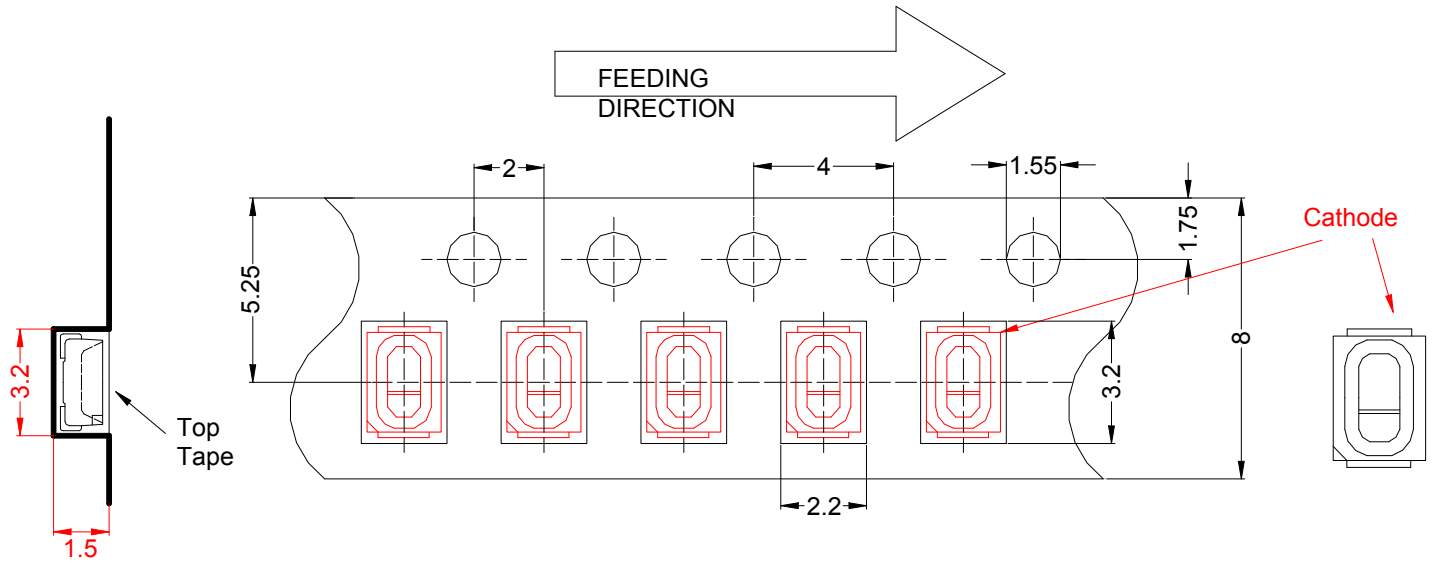

Reel Dimension

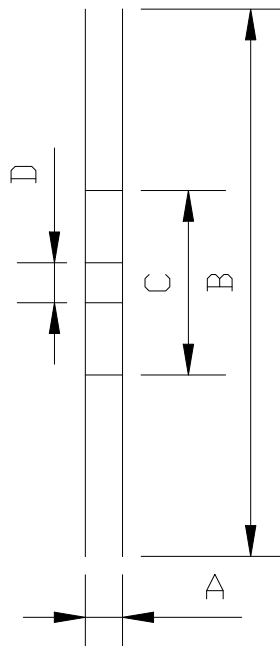
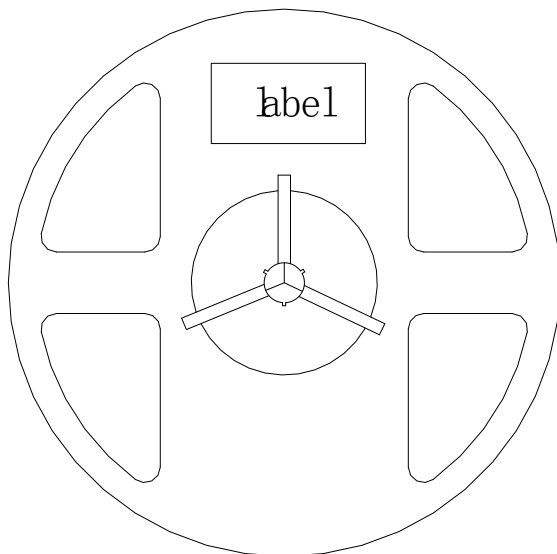

A	8.0±0.1mm
B	178±1mm
C	60±1mm
D	13.0±0.5mm

NOTE:

1. The tolerances unless mentioned ± 0.1 mm. Unit : mm
2. 3,000 pcs/Reel.

Label Form Specification

WCN Opto Group Co., Ltd

P/N: ROHS



QTY: PCS IV:



LOT NO: WL:



MADE IN CHINA

VF:

P/N	Part Number
QTY	Packing Quantity
LOT NO	Made Date
IV	Luminous intensity
WL	Dominant wavelength
VF	Forward Voltage

Moisture Resistant Packing Process



Test items and results of reliability

Type	Test Item	Test Conditions	Note	Number of Damaged
Environmental Sequence	Reflow	Ta=260°C max T=10s	2 times	0/22
	Temperature Cycle	-40°C 30min ↑↓ 100°C 30min	100 cycle	0/22
	Thermal Shock	-40°C 15min ↑↓ 100°C 15min	100 cycle	0/22
	High Humidity Heat Cycle	30°C ↔ 65°C 90%RH 24hrs/1cycle	10 cycle	0/22
	High Temperature Storage	Ta=100°C	1000 hrs	0/22
	Low Temperature Storage	Ta=-40°C	1000 hrs	0/22
	Humidity Heat Storage	Ta=60°C RH=90%	1000 hrs	0/22
	Low Temperature Storage	Ta=-30°C	1000 hrs	0/22
Operation Sequence	Life Test	Ta=25°C IF=20mA	1000 hrs	0/22
	High Humidity Heat Life Test	60°C RH=90% IF=10mA	500 hrs	0/22
	Low Temperature Life Test	Ta=-20°C IF=20mA	1000 hrs	0/22

Reflow Profile

■ Reflow Temp/Time



Notes:

1. We recommend the reflow temperature 245°C (±5°C). the maximum soldering temperature should be limited to 260°C.
2. Don't cause stress to the epoxy resin while it is exposed to high temperature.
3. Number of reflow process shall be 2 times or less.

■ Soldering iron

Basic spec is $\leq 5\text{sec}$ when 260°C. If temperature is higher, time should be shorter (+10°C → -1sec). Power dissipation of iron should be smaller than 20W, and temperatures should be controllable. Surface temperature of the device should be under 230°C.

■ Rework

1. Customer must finish rework within 5 sec under 260°C.
2. The head of iron can not touch copper foil
3. Twin-head type is preferred.



■ Avoid rubbing or scraping the resin by any object, during high temperature, for example reflow solder etc.

Test circuit and handling precautions

■ Test circuit



■ Handling precautions

1. Over-current-proof

Customer must apply resistors for protection; otherwise slight voltage shift will cause big current change (Burn out will happen).

2. Storage

2.1 It is recommended to store the products in the following conditions:

Humidity: 60% R.H. Max.

Temperature : 5°C~30°C (41°F~86°F)

2.2 Shelf life in sealed bag: 12 month at <5°C~30°C and <30% R.H. After the package is

Opened, the products should be used within a week or they should be keeping to stored at ≤ 20 R.H. with zip-lock sealed.

3. Baking

It is recommended to baking before soldering when the pack is unsealed after 72hrs. The Conditions are as followings:

3.1 70±3°C x(12~24hrs) and <5%RH, taped reel type

3.2 100±3°C x(45min~1hr), bulk type

3.3 130±3°C x(15~30min), bulk type