

# **WCN4-0028R6-C21**

## **SPECIFICATION**

<b>WCN</b>			<b>CUSTOMER Confirmed</b>
<b>Prepared by</b>	<b>Checked by</b>	<b>Approved by</b>	
<b>Fei</b> 2016-4-1	<b>Athena</b>	<b>William</b>	
<b>REVISION RECORD</b>			

**REVISION: A0**

### Outer Dimension:

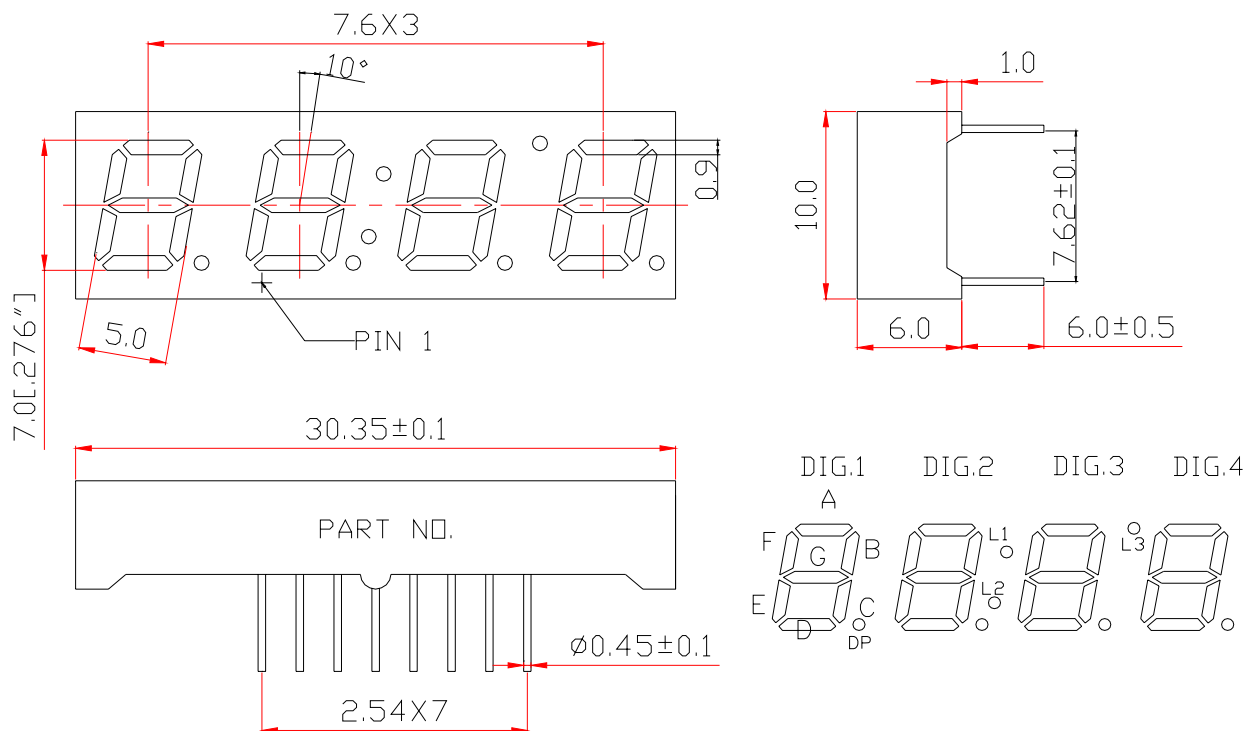

Notes: Unless otherwise stated, The tolerance is ±0.25mm.

### Circuit Diagram:

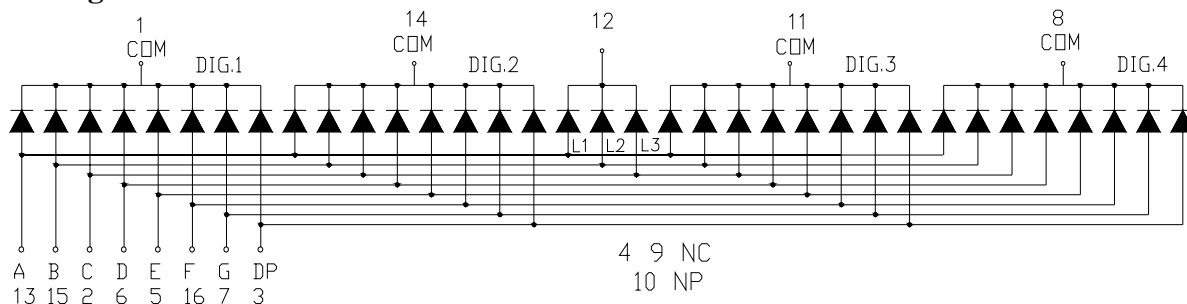

### Pin Connection:

PIN NO.	CONNECTION	PIN NO.	CONNECTION
1	Common Cathode Dig1	9	NO Connected
2	Anode C	10	NO PIN.
3	Anode DP	11	Common Cathode Dig3
4	NO Connected	12	Common Cathode L1~L3
5	Anode E	13	Anode A
6	Anode D	14	Common Cathode Dig2
7	Anode G	15	Anode B
8	Common Cathode Dig4	16	Anode F

■ **Features:**

- High Reliability
- Color: Super Bright Red.
- Low Power Requirement
- Easy Assembly

■ **Description:**

- Four Digit Display
- Digit Height:7.0mm(0.28" )
- Black Face and Milky Segment

■ **Absolute Maximum Rating (Ta=25°C):**

Parameter	Symbol	Condition	Color	Rating	Units
Power Dissipation Per Segment	P <sub>d</sub>	—	Red	65	mW
Forward Current Per Segment	I <sub>F</sub>	—	Red	25	mA
Peak Forward Current Per Segment	I <sub>FP</sub>	1/10 Duty 10KHz	Red	100	mA
Reverse Voltage Per Segment	V <sub>R</sub>	—	Red	5	V
Operating Temperature Range	T <sub>opr</sub>	—	—	-35~+85	°C
Storage Temperature Range	T <sub>stg</sub>	—	—	-35~+85	°C

■ **Electrical/Optical Characteristics Rating(Ta=25°C)**

Item	Symbol	Test conditions	Location	Rating			Units
				Min.	Typ.	Max.	
Forward Voltage	V <sub>F</sub>	I <sub>F</sub> =20mA	Per Segment	—	2.00	2.60	V
Reverse Current	I <sub>R</sub>	V <sub>R</sub> =5V	Per Segment	—	—	100	μA
Luminous Intensity	I <sub>v</sub>	I <sub>F</sub> =10mA	Per Segment	4001	6500	—	μcd
Peak Emission Wave Length	λ <sub>P</sub>	I <sub>F</sub> =20mA	Per Segment	—	635	—	nm
	λ <sub>D</sub>			—	630	—	
Spectral Line Half Width	△λ	I <sub>F</sub> =20mA	Per Segment	—	20	—	nm
Luminous Intensity Matching Ratio (Segment to Segment)	I <sub>v-m</sub>	I <sub>F</sub> =10mA	—	—	—	1.2:1	

■ **Luminous Intensity Sorting: (Luminous Intensity Tolerance is +/-10%)**

Rank	Symbol	Condition	Min	Max	Unit
L	L	I <sub>F</sub> =10mA	4001	5000	μcd
M	M	I <sub>F</sub> =10mA	5001	6100	μcd
N	N	I <sub>F</sub> =10mA	6101	7200	μcd
O	O	I <sub>F</sub> =10mA	7201	8500	μcd
P	P	I <sub>F</sub> =10mA	8501	10500	μcd

■ **Soldering Conditions: Soldering Temp. ≤+260°C, Soldering Time. ≤3sec.**  
 (at 2mm Distance from The Case of Reflector Edge)

■ **Typical Elector-Optical Characteristics Curve:**

Forward current vs. Forward voltage

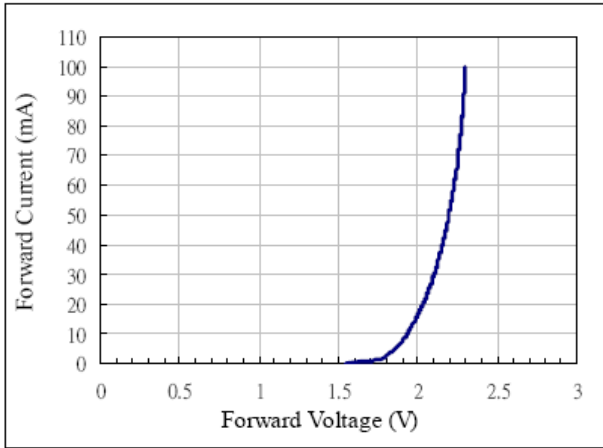

Relative intensity vs. Forward current

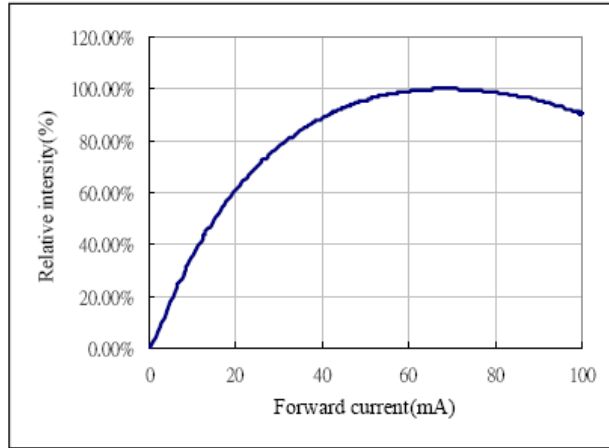

Forward voltage vs. Temperature

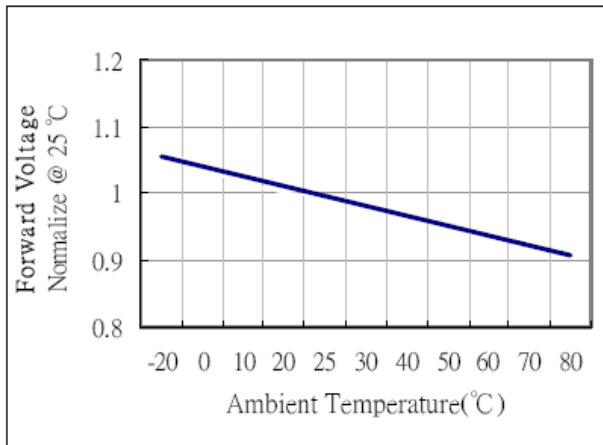

Relative intensity vs. Temperature

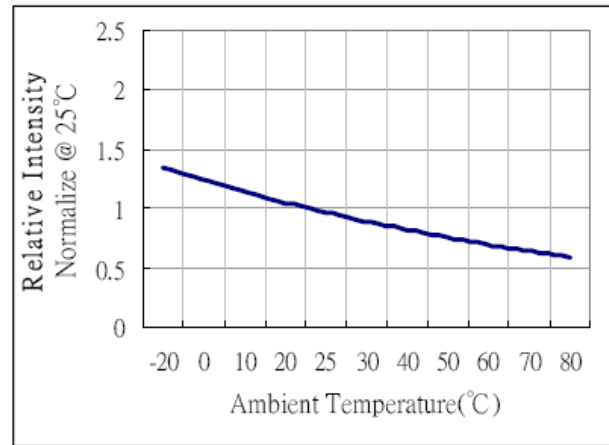

Relative intensity vs. Wavelength

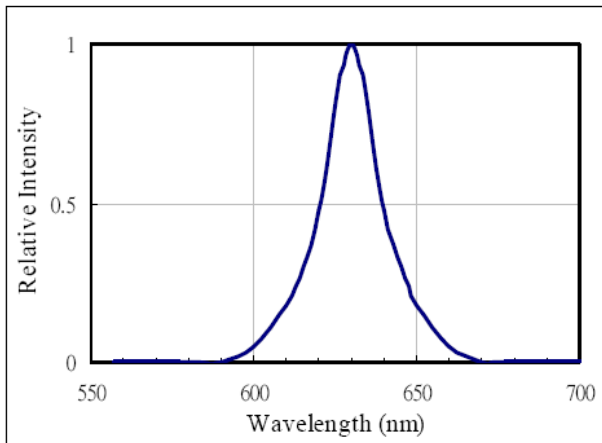

## ■ LED Displays Reliability Test:

CLASSIFICATION	TEST ITEM	DESCRIPTION AND TEST CONDITION
ENDURANCE TEST	OPERATION LIFE	EVALUATES RESISTANCE OF THE DEVICE WHEN OPERATED AT ELECTRICAL STRESS $T_a$ = UNDER ROOM TEMPERATURE $I_F = I_F \text{ max}$
	HIGH TEMPERATURE HIGH HUMIDITY STORAGE	EVALUATES MOISTURE RESISTANCE OF THE DEVICE WHEN STORED FOR A LONG TERM AT HIGH TEMPERATURE AND HUMIDITY $T_a = 65 \pm 5^\circ\text{C}$ RH=90~95%RH TEST TIME=240± 2Hrs
	HIGH TEMPERATURE STORAGE	EVALUATES DEVICE DURABILITY FOR LONG TERM STORAGE IN HIGH TEMPERATURE $T_a = 85 \pm 5^\circ\text{C}$ (COB: $T_a = 65 \pm 5^\circ\text{C}$ ) TEST TIME=1000Hrs(-24Hrs, +72Hrs)
	LOW TEMPERATURE STORAGE	EVALUATES DEVICE DURABILITY FOR LONG TERM STORAGE IN LOW TEMPERATURE $T_a = -35 \pm 5^\circ\text{C}$ TEST TIME=1000Hrs(-24Hrs, +72Hrs)
ENVIRONMENTAL TEST	TEMPERATURE CYCLING	EVALUATES RESISTANCE OF DEVICE AT THERMAL STRESSES OR EXPANSION AND CONTRACTION $85^\circ\text{C} \sim 25^\circ\text{C} \sim -35^\circ\text{C} \sim 25^\circ\text{C}$ 30min 5min 30min 5min 10 CYCLES(COB: $T_{\text{hot}}=65^\circ\text{C}$ , $T_{\text{cold}}=-25^\circ\text{C}$ )
	THERMAL SHOCK	EVALUATES DEVICE STRUCTURE AND STRUCTURE AND MECHANICAL RESISTANCE WHEN SUDDENLY EXPOSED AT SERVE CHANGES $85 \pm 5^\circ\text{C} \sim -35 \pm 5^\circ\text{C}$ 10min 10min 10 CYCLES(COB: $T_{\text{hot}}=65^\circ\text{C}$ , $T_{\text{cold}}=-25^\circ\text{C}$ )
	SOLDERABILITY	EVALUATES SOLDERABILITY ON LEADS OF DEVICE $T_{\text{SOL}}=230 \pm 5^\circ\text{C}$ DWELL TIME=5±1sec.
	SOLDER RESISTANCE	EVALUATES RESISTANCE TO THERMAL STRESS CAUSED BY SOLDERING $T_{\text{SOL}}=260 \pm 5^\circ\text{C}$ DWELL TIME=10±1sec.

## ■ Packing method A:

140 pcs / Red Expandable Polyethylene.

840 pcs / Box(360\*175\*130mm).

5040 pcs / Carton(550\*380\*280mm).

## ■ Packing method B:

16 pcs / IC Tube.(525\*13\*18.8)

1248 pcs / Box(537\*175\*125mm).

4992 pcs / Carton(550\*380\*280mm).