

WCN4-0028GU-C21

SPECIFICATION

WCN			CUSTOMER Confirmed
Prepared by	Checked by	Approved by	
Fei 2016-4-1	Athena	William	
REVISION RECORD			



REVISION: A0

Outer Dimension:

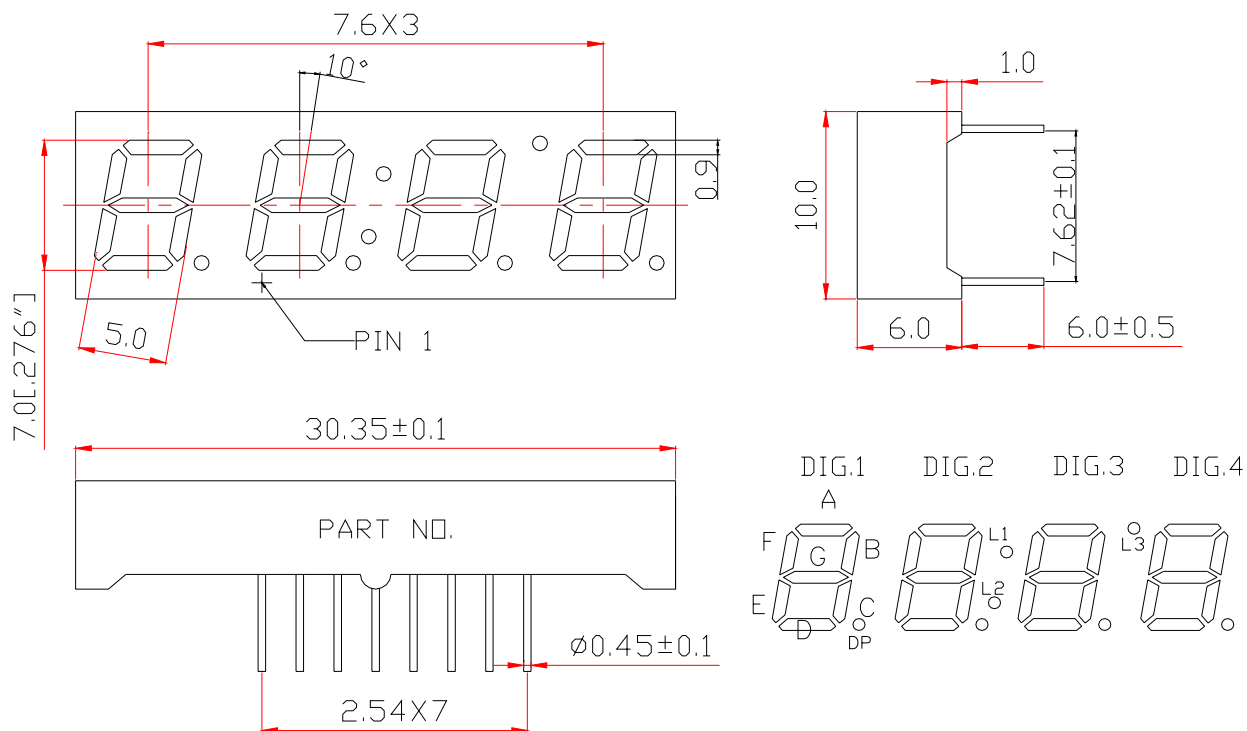

Notes: Unless otherwise stated, The tolerance is ±0.25mm.

Circuit Diagram:

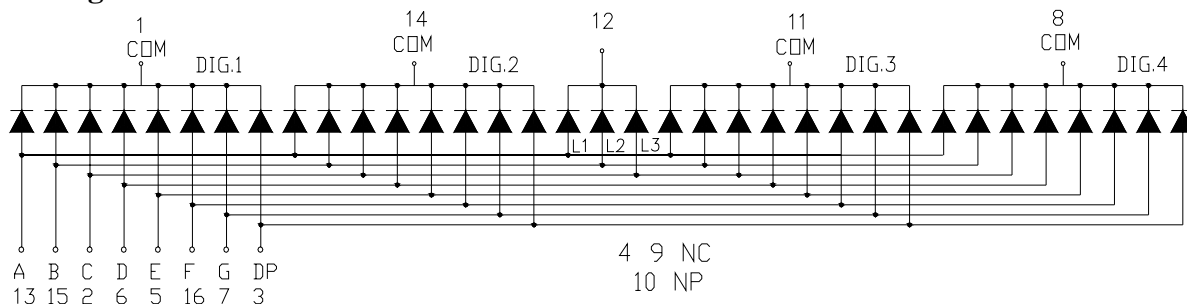

Pin Connection:

PIN NO.	CONNECTION	PIN NO.	CONNECTION
1	Common Cathode Dig1	9	NO Connected
2	Anode C	10	NO PIN.
3	Anode DP	11	Common Cathode Dig3
4	NO Connected	12	Common Cathode L1~L3
5	Anode E	13	Anode A
6	Anode D	14	Common Cathode Dig2
7	Anode G	15	Anode B
8	Common Cathode Dig4	16	Anode F

WCN Opto Group Co., Limited

■ **Features:**

- High Reliability
- Color: Yellow Green
- Low Power Requirement
- Easy Assembly

■ **Description:**

- Four Digit Display
- Digit Height:7.0mm(0.28")
- Black Face and Milky Segment

■ **Absolute Maximum Rating (Ta=25°C):**

Parameter	Symbol	Condition	Color	Rating	Units
Power Dissipation Per Segment	P _d	—	Yellow Green	65	mW
Forward Current Per Segment	I _F	—	Yellow Green	25	mA
Peak Forward Current Per Segment	I _{FP}	1/10 Duty 10KHz	Yellow Green	100	mA
Reverse Voltage Per Segment	V _R	—	Yellow Green	5	V
Operating Temperature Range	T _{opr}	—	—	-35~+85	°C
Storage Temperature Range	T _{stg}	—	—	-35~+85	°C

■ **Electrical/Optical Characteristics Rating(Ta=25°C)**

Item	Symbol	Test conditions	Location	Rating			Units
				Min.	Typ.	Max.	
Forward Voltage	V _F	I _F =20mA	Per Segment	—	2.25	2.60	V
Reverse Current	I _R	V _R =5V	Per Segment	—	—	100	μA
Luminous Intensity	I _v	I _F =10mA	Per Segment	1001	2000	—	μcd
Peak Emission Wave Length	λ _P	I _F =20mA	Per Segment	—	568	—	nm
	λ _D			—	571	—	
Spectral Line Half Width	Δλ	I _F =20mA	Per Segment	—	20	—	nm
Luminous Intensity Matching Ratio (Segment to Segment)	I _{v-m}	I _F =10mA	—	—	—	1.2:1	

■ **Luminous Intensity Sorting: (Luminous Intensity Tolerance is +/-10%)**

Rank	Symbol	Condition	Min	Max	Unit
G	G	I _F =10mA	1001	1350	μcd
H	H	I _F =10mA	1351	1750	μcd
I	I	I _F =10mA	1751	2350	μcd
J	J	I _F =10mA	2351	3050	μcd
K	K	I _F =10mA	3051	4000	μcd

■ **Hue Grade: I_F =10mA (Hue:+/-1nm)**

Rank	Symbol	Hue Range	Units
3	3	569.1~571.0	nm
4	4	571.1~573.0	nm

■ **Soldering Conditions: Soldering Temp. ≤+260°C, Soldering Time. ≤3sec.**
 (at 2mm Distance from The Case of Reflector Edge)

Typical Elector-Optical Characteristics Curve:

Fig 1. Forward Current vs. Forward Voltage

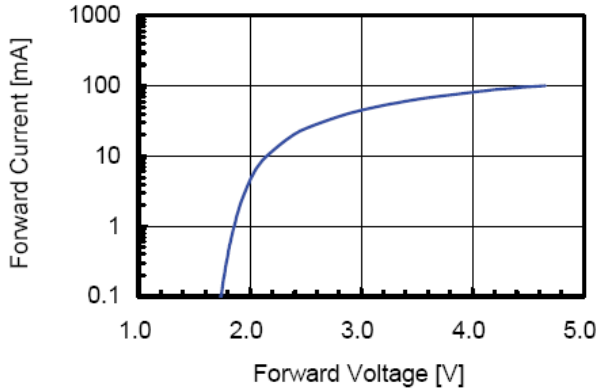

Fig 2. Relative Intensity vs. Forward Current

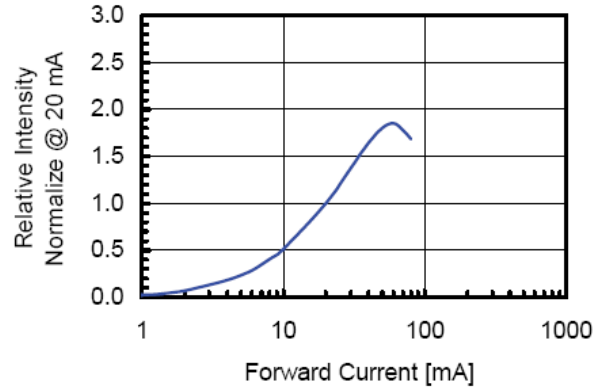

Fig 3. Forward Voltage vs. Temperature

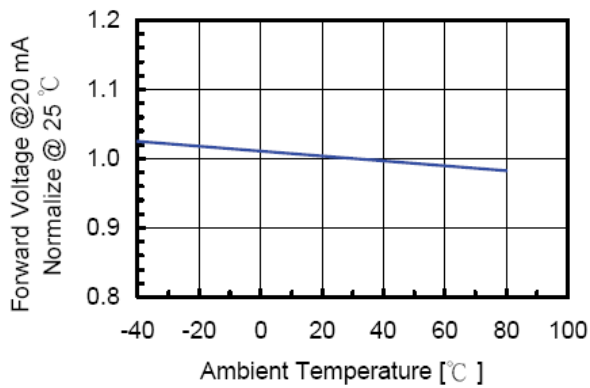

Fig 4. Relative Intensity vs. Temperature

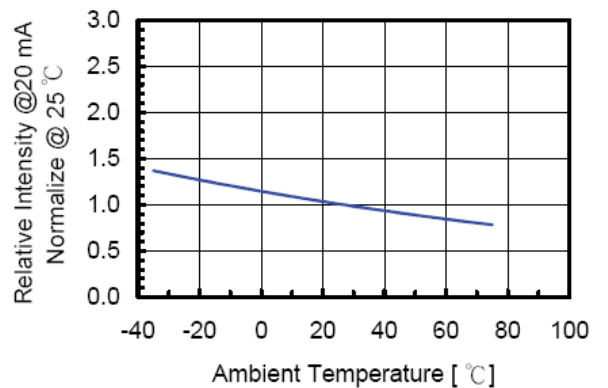
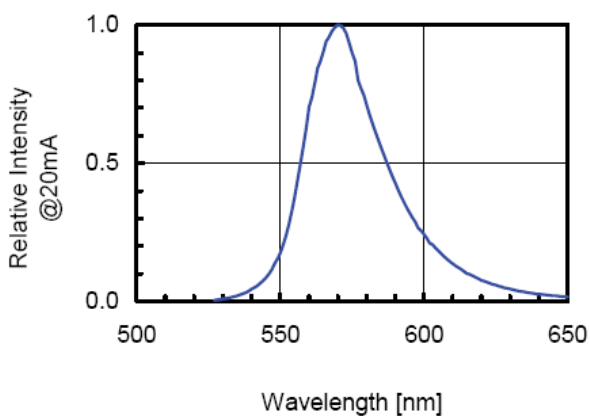

Fig 5. Relative Intensity vs. Wavelength



■ LED Displays Reliability Test:

CLASSIFICATION	TEST ITEM	DESCRIPTION AND TEST CONDITION
ENDURANCE TEST	OPERATION LIFE	EVALUATES RESISTANCE OF THE DEVICE WHEN OPERATED AT ELECTRICAL STRESS $T_a =$ UNDER ROOM TEMPERATURE $I_F = I_F \text{ max}$
	HIGH TEMPERATURE HIGH HUMIDITY STORAGE	EVALUATES MOISTURE RESISTANCE OF THE DEVICE WHEN STORED FOR A LONG TERM AT HIGH TEMPERATURE AND HUMIDITY $T_a = 65 \pm 5^\circ\text{C}$ RH=90~95%RH TEST TIME=240 \pm 2Hrs
	HIGH TEMPERATURE STORAGE	EVALUATES DEVICE DURABILITY FOR LONG TERM STORAGE IN HIGH TEMPERATURE $T_a = 85 \pm 5^\circ\text{C}$ (COB: $T_a = 65 \pm 5^\circ\text{C}$) TEST TIME=1000Hrs(-24Hrs, +72Hrs)
	LOW TEMPERATURE STORAGE	EVALUATES DEVICE DURABILITY FOR LONG TERM STORAGE IN LOW TEMPERATURE $T_a = -35 \pm 5^\circ\text{C}$ TEST TIME=1000Hrs(-24Hrs, +72Hrs)
ENVIRONMENTAL TEST	TEMPERATURE CYCLING	EVALUATES RESISTANCE OF DEVICE AT THERMAL STRESSES OR EXPANSION AND CONTRACTION $85^\circ\text{C} \sim 25^\circ\text{C} \sim -35^\circ\text{C} \sim 25^\circ\text{C}$ 30min 5min 30min 5min 10 CYCLES(COB: $T_{\text{hot}}=65^\circ\text{C}$, $T_{\text{cold}}=-25^\circ\text{C}$)
	THERMAL SHOCK	EVALUATES DEVICE STRUCTURE AND STRUCTURE AND MECHANICAL RESISTANCE WHEN SUDDENLY EXPOSED AT SERVE CHANGES $85 \pm 5^\circ\text{C} \sim -35 \pm 5^\circ\text{C}$ 10min 10min 10 CYCLES(COB: $T_{\text{hot}}=65^\circ\text{C}$, $T_{\text{cold}}=-25^\circ\text{C}$)
	SOLDERABILITY	EVALUATES SOLDERABILITY ON LEADS OF DEVICE $T_{\text{SOL}}=230 \pm 5^\circ\text{C}$ DWELL TIME=5 \pm 1sec.
	SOLDER RESISTANCE	EVALUATES RESISTANCE TO THERMAL STRESS CAUSED BY SOLDERING $T_{\text{SOL}}=260 \pm 5^\circ\text{C}$ DWELL TIME=10 \pm 1sec.

■ Packing method A:

140 pcs / Red Expandable Polyethylene.

840 pcs / Box(360*175*130mm).

5040 pcs / Carton(550*380*280mm).

■ Packing method B:

16 pcs / IC Tube.(525*13*18.8)

1248 pcs / Box(537*175*125mm).

4992 pcs / Carton(550*380*280mm).