

## WCN Opto Group Co., Limited

Customer Name:

Date:

2016-07-01

Part No:

WCN1S-1028SR-A1

Product Group  
Description:

LED Display

Customer Part No:

Approval Date:

Customer  
Confirmation

Approved by

Checked by

Athena  
2016-07-01

Prepared By

Fei  
2016-07-01

Country of Origin: China

World Components Network Service Ltd

5th Floor,Block A-2,Xuxingda Ind Zone  
Shiyan Town,Bao An District , Shenzhen  
Tel : (86)755-29000022  
Fax : (86)755-29000023



RoHS



www . wcnopto.net

# WCN Opto Group Co., Limited

---

## Table of Contents

<b>NO.</b>	<b>ITEM</b>	<b>PAGE</b>
1	Cover	1
2	Table of Contents	2
3	Revision Record	3
4	Description	4
5	Outer Dimension and Circuit Diagram	5
6	Absolute Maximum Rating and Electrical/Optical Characteristics Rating	6
7	Typical Electrical/ Optical Characteristic Curves and Spectrometer	7
8	Packaging Data	8
9	Moisture Proof Packaging	9



# WCN Opto Group Co., Limited

## REVISION RECORD

MARKER	Matter for revision	SHEET	DTAE	MAKER	APPOVED SIGN	
	Reason for revision					
A0	P# WCN1S-1028B7-A1	Whole Spec	2016-2-23	Fei	Athena	
	New Version issued					
A1	Change Out Size Shape	Page.5	2015-8-27	Fei	Athena	
A2	New Version issued	Whole Spec	2016-07-01	Fei	Athena	

**1. Type No./Manufacture's Name**

WCN1S-1028SR-A1 / World Components Network Service Ltd.

**2. Features:**

- High Reliability
- Low Power Requirement
- Easy Assembly

**3. Faction: Display Digit Characteristic****4. Soldering Conditions: Soldering Temp.  $260 \pm 5$  °C, Soldering Time. 3~5 sec.**

Soldering Power <30 W.

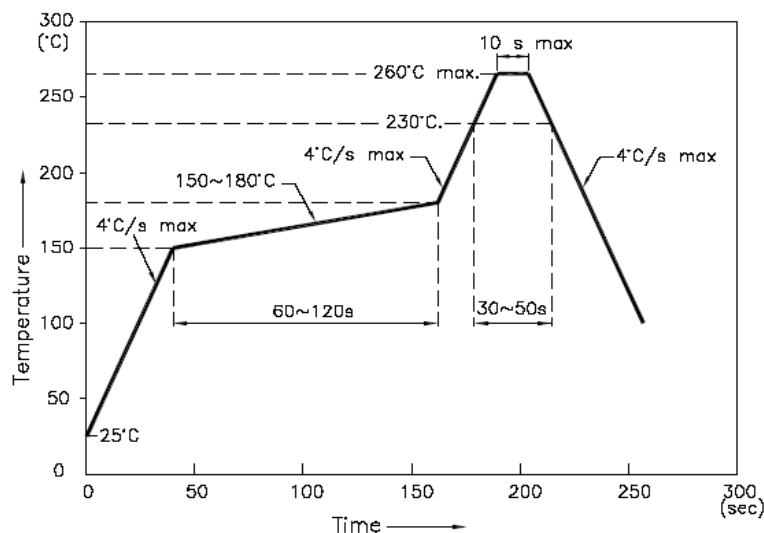
**5. Re-flow Temp/Time****NOTES:**

5.1. We recommend the re-flow temperature  $245^{\circ}\text{C} (\pm 5^{\circ}\text{C})$ . the maximum soldering temperature should be limited to  $260^{\circ}\text{C}$ .

5.2. Don't cause stress to the epoxy resin while it is exposed to high temperature. Number of re-flow process shall be 2 times or less.

**6. Description:**

- Single Digit LED Display
- Digit Height: 7.0mm (0.28" )
- Gray Face and Milky Segment
- Color: Red

### Outer Dimension:

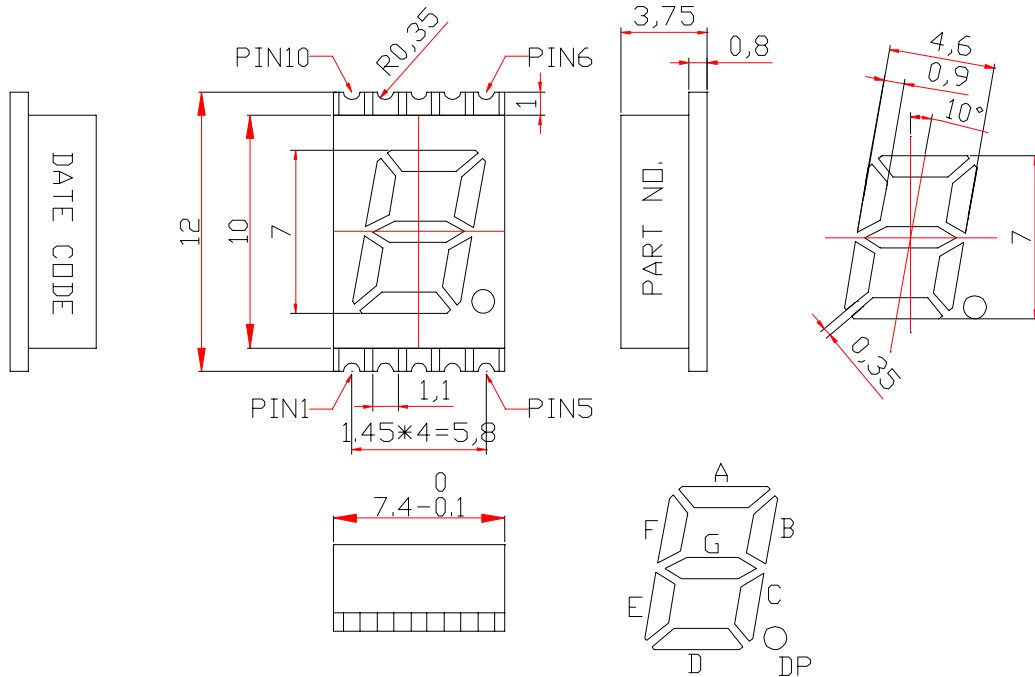

Notes: Unless otherwise stated, the tolerance is  $\pm 0.25\text{mm}$ .

### Circuit Diagram:

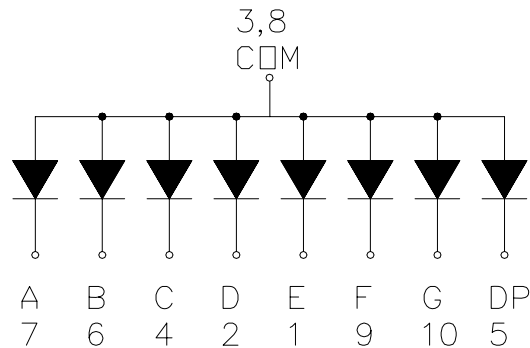

### Pin Connection:

PIN NO.	CONNECTION	PIN NO.	CONNECTION
1	Cathode E	6	Cathode B
2	Cathode D	7	Cathode A
3	Common Anode	8	Common Anode
4	Cathode C	9	Cathode F
5	Cathode DP	10	Cathode G

# WCN Opto Group Co., Limited

## ■ ABSOLUTE MAXIMUM RATINGS AT TA=25°C

Parameter	Symbol	Condition	Color	Rating	Units
Power Dissipation Per Segment	$P_d$	—	Red	65	mW
Forward Current Per Segment	$I_F$	—	Red	25	mA
Peak Forward Current Per Segment	$I_{FP}$	1/10 Duty 1KHz	Red	100	mA
Reverse Voltage Per Segment	$V_R$	—	Red	5	V
Operating Temperature Range	$T_{opr}$	—	—	-40~+105	°C
Storage Temperature Range	$T_{stg}$	—	—	-40~+105	°C

## ■ Electrical/Optical Characteristics Rating(Ta=25°C)

Item	Symbol	Test conditions	Location	Rating			Units
				Min.	Typ.	Max.	
Forward Voltage	$V_F$	$I_F=20mA$	Per Chip	1.8	2.0	2.6	V
Reverse Current	$I_R$	$V_R=5V$	Per Chip	—	—	100	$\mu A$
Luminous Intensity	$I_V$	$I_F=10mA$	Per Chip	4001	6500	10500	ucd
Wave Length	$\lambda_P$	$I_F=20mA$	Per Chip	—	635	—	nm
	$\lambda_D$			—	630	—	
Luminous Intensity Matching Ratio (Segment To Segment)	$I_{v-m}$	$I_F=10mA$				1.2:1	

## ■ Luminous Intensity Sorting: (Luminous intensity tolerance :+/-10%)

Rank	Symbol	Condition	Min	Max	Unit
L	L	$I_F=10mA$	4001	5000	ucd
M	M	$I_F=10mA$	5001	6100	$\mu cd$
N	N	$I_F=10mA$	6101	7200	$\mu cd$
O	O	$I_F=10mA$	7201	8500	$\mu cd$
P	P	$I_F=10mA$	8501	10500	$\mu cd$

■ **Typical Optical-Electronic Characteristic Curves**

Forward current vs. Forward voltage

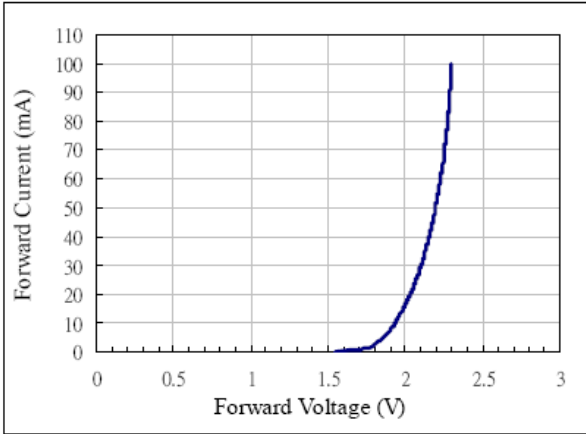

Relative intensity vs. Forward current

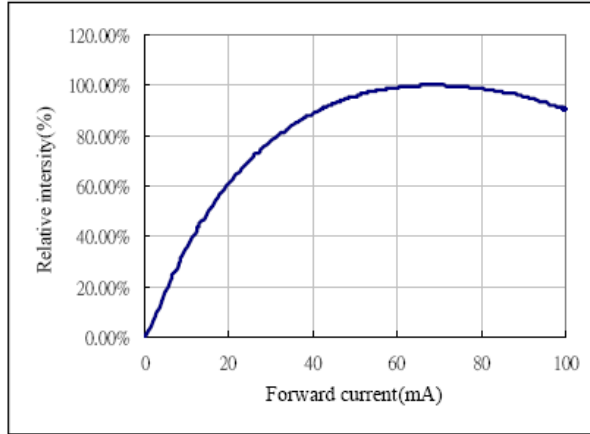

Forward voltage vs. Temperature

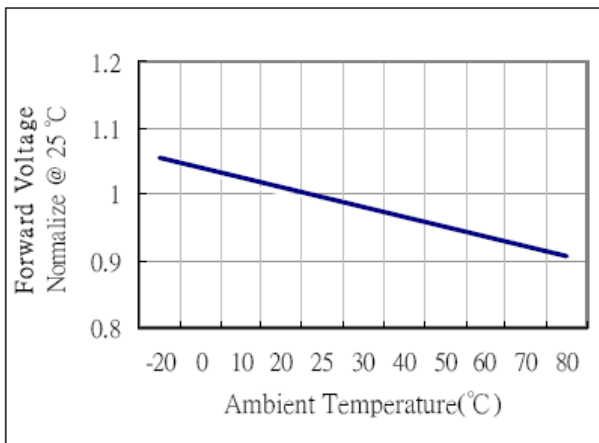

Relative intensity vs. Temperature

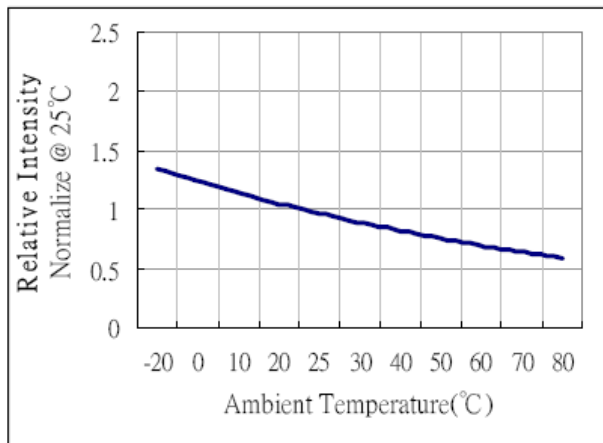

Relative intensity vs. Wavelength

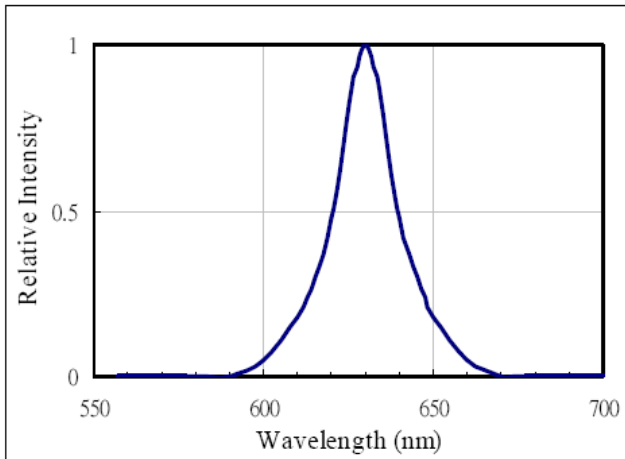

■ Packing Reel Dimensions(mm):

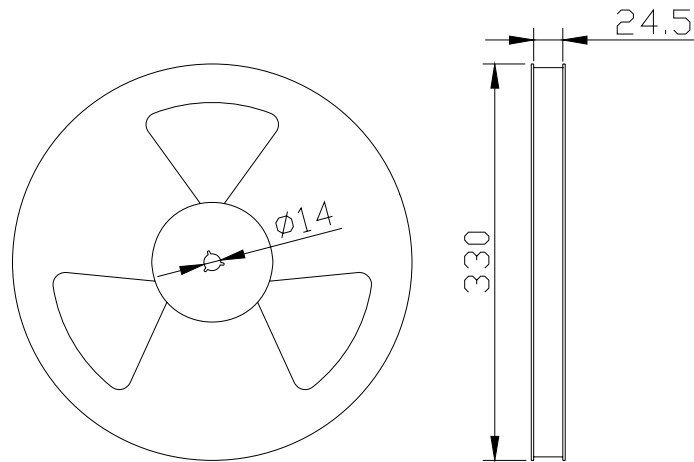

■ Dimensions of Tape (Unit: mm)

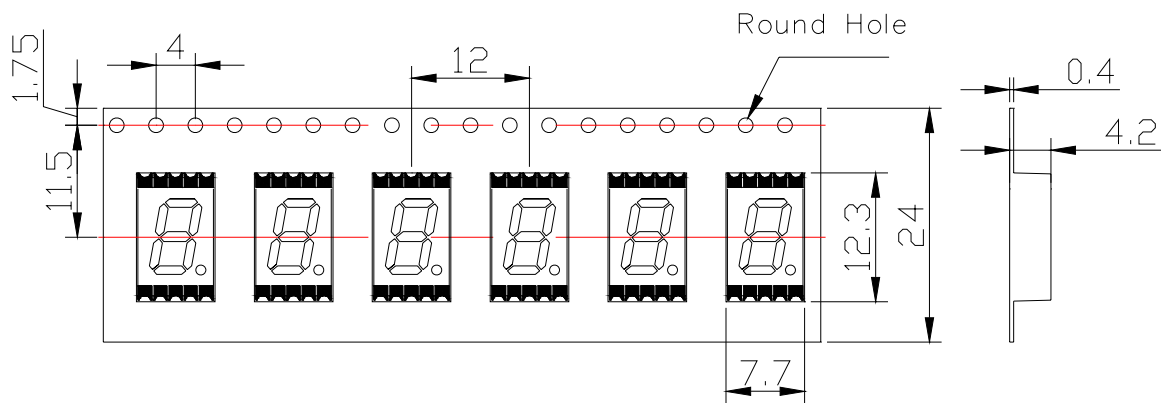

■ One Reel contained 1200 PCS products:

■ Recommended Soldering Pattern:

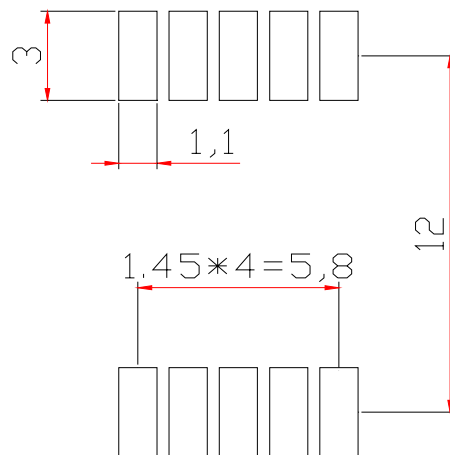



■ **Moisture Proof Packaging :**

All N/D SMD displays are shipped in moisture proof package. The displays should be stored at 30°C or less and 60% RH or less. Once the package opened, moisture absorption begins.

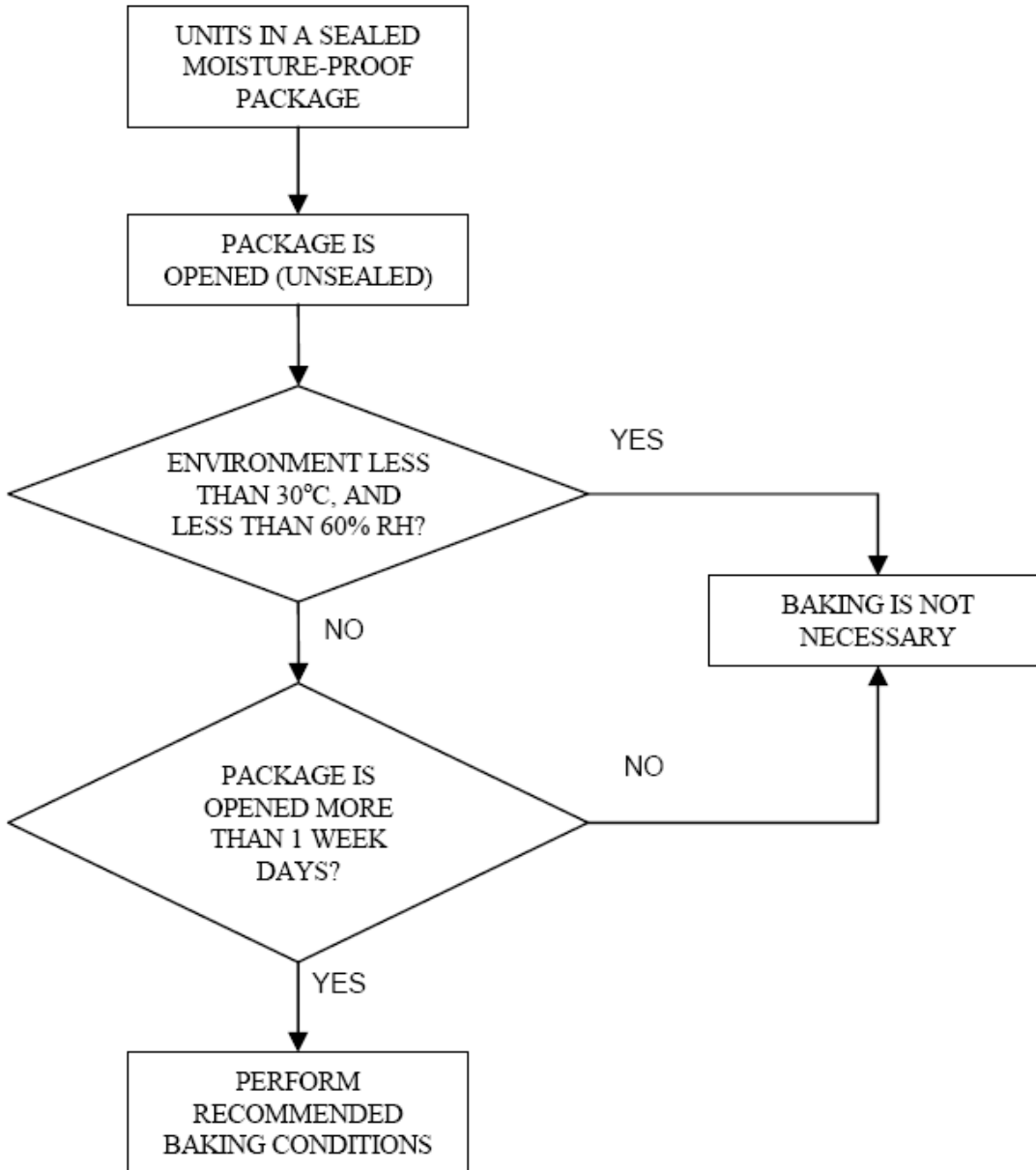

■ **Baking Conditions:**

If the parts not stored in dry conditions, they must be baked before re-flow to prevent damage to the parts.

Package	Temperature	Time
In Reel	60 °C	≥ 48hours
In Bulk	100 °C	≥ 4hours
	125 °C	≥ 2hours

■ **Baking should only be done once.**